

## Quad Channel Low Capacitance ESD Protection Array

**UM5204EEAF SC70-6/SC88/SOT363**  
**UM5204EEBF SC89-6/SOT563/SOT666**  
**UM5204EECF TSOP-6/SOT23-6**

### General Description

UM5204EEXF are surge rated diode arrays designed to protect high speed data interfaces. This series has been specifically designed to protect sensitive components which are connected to data and transmission lines from over-voltage caused by ESD (electrostatic discharge).

The unique design incorporates surge rated, low capacitance steering diodes and a TVS diode in a single package. During transient conditions, the steering diodes direct the transient to either the positive side of the power supply line or to ground. The internal TVS diode prevents over-voltage on the power line, protecting any downstream components.

The low capacitance array configuration allows the user to protect four high-speed data or transmission lines. The low inductance construction minimizes voltage overshoot during high current surges. This device is optimized for ESD protection of portable electronics. They may be used to meet the ESD immunity requirements of IEC 61000-4-2, Level 4 ( $\pm 15\text{kV}$  air,  $\pm 8\text{kV}$  contact discharge).

### Applications

- USB 2.0
- USB OTG
- Monitors and Flat Panel Displays
- Digital Visual Interface (DVI)
- High-Definition Multimedia Interface (HDMI)
- SIM Ports
- IEEE 1394 Firewire Ports

### Features

- Transient Protection for High-Speed Data Lines to IEC 61000-4-2 (ESD)  $\pm 15\text{kV}$  (Air),  $\pm 8\text{kV}$  (Contact)
- Array of Surge Rated Diodes with Internal TVS Diode
- Protects up to Four I/O Lines & Power Line
- Low Capacitance ( $<2\text{pF}$ ) for High-Speed Interfaces
- No Insertion Loss to 2.0GHz
- Low Leakage Current and Clamping Voltage
- Low Operating Voltage: 5.0V
- Solid-State Silicon-Avalanche Technology

### Pin Configurations

### Top View

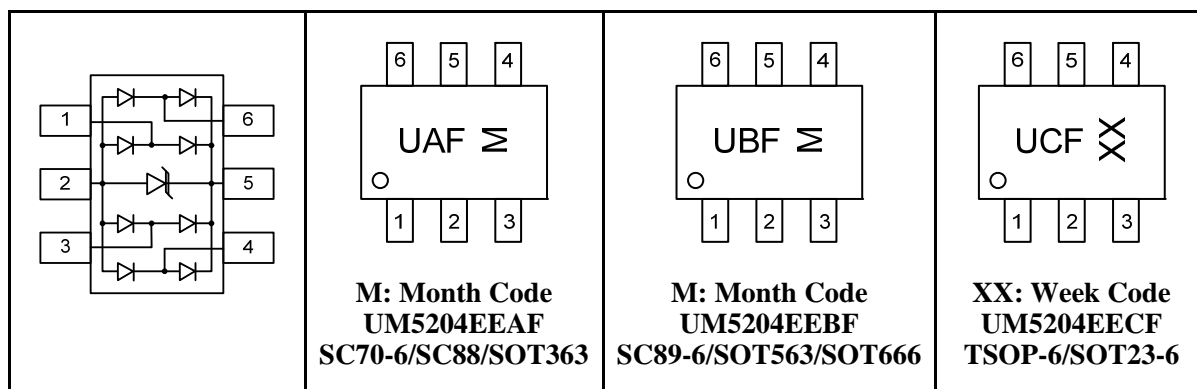

## Ordering Information

Part Number	Working Voltage	Packaging Type	Channel	Marking Code	Shipping Qty
UM5204EEAF	5.0V	SC70-6/SC88/SOT363	4	UAF	3000pcs/7 Inch Tape & Reel
UM5204EEBF		SC89-6/SOT563/SOT666		UBF	
UM5204EECF		TSOP-6/SOT23-6		UCF	

## Absolute Maximum Ratings

Rating	Symbol	Value	Unit
Peak Pulse Power ( $t_p=8/20\mu s$ )	$P_{pk}$	150	Watts
Peak Pulse Current ( $t_p=8/20\mu s$ )	$I_{pp}$	6	A
ESD per IEC 61000-4-2 (Air) ESD per IEC 61000-4-2 (Contact)	$V_{ESD}$	$\pm 15$ $\pm 8$	kV
Operating Temperature	$T_J$	-55 to +125	$^{\circ}C$
Storage Temperature	$T_{STG}$	-55 to +150	$^{\circ}C$

## Electrical Characteristics

Parameter	Symbol	Test Conditions	Min	Typ	Max	Unit
Reverse Stand-Off Voltage	$V_{RWM}$				5.0	V
Reverse Breakdown Voltage	$V_{BR}$	$I_1=1mA$ , Pin 5 to 2	6.0			V
Reverse Leakage Current	$I_R$	$V_{RWM}=5V$ , $T=25^{\circ}C$ Pin 5 to 2			2	$\mu A$
Clamping Voltage	$V_C$	$I_{pp}=1A$ , $8/20\mu s$ Any Pin to Pin 2			15	V
Clamping Voltage	$V_C$	$I_{pp}=6A$ , $8/20\mu s$ Any Pin to Pin 2			25	V
Junction Capacitance	$C_j$	$V_R=0V$ , $f=1MHz$ Any I/O Pin to Pin 2 (Note 1)			2	pF
		$V_R=0V$ , $f=1MHz$ Between I/O Pins (Note 1)			1	pF

Note 1: I/O pins are pin 1, 3, 4, and 6

## Typical Operating Characteristics

**Non-Repetitive Peak Pulse Power vs. Pulse Time**

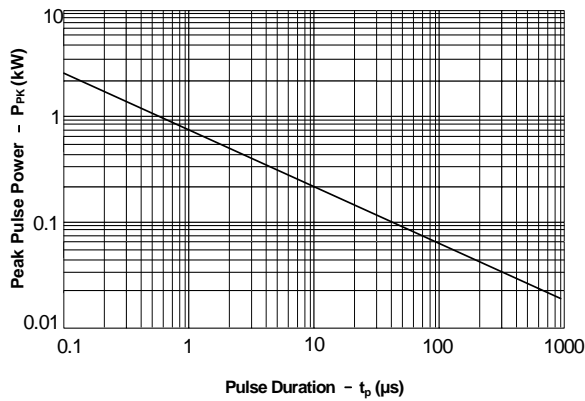

**Power Derating Curve**

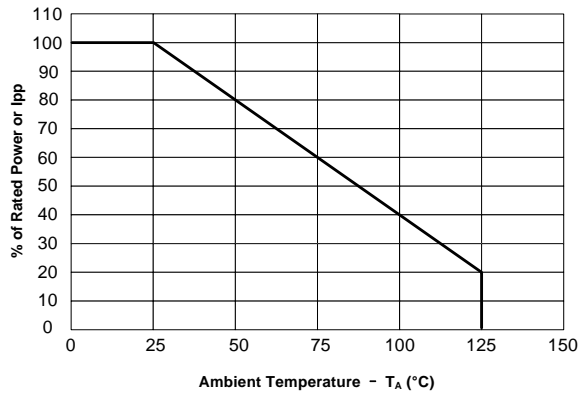

**Pulse Waveform**

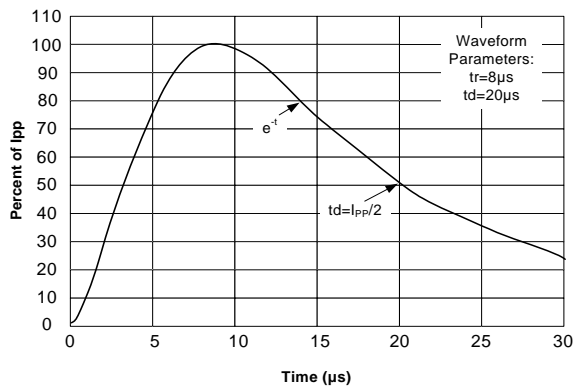

**Clamping Voltage vs. Peak Pulse Current**

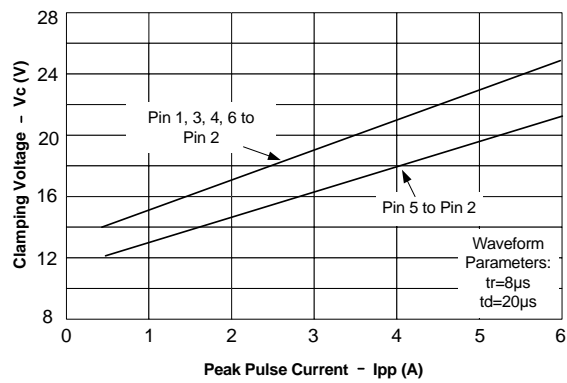

**Forward Voltage vs. Forward Current**

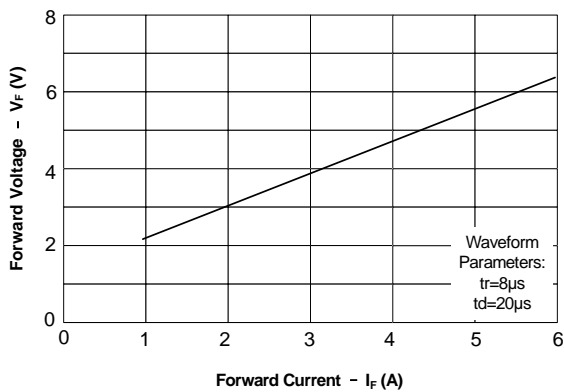

**Junction Capacitance vs. Reverse Voltage**

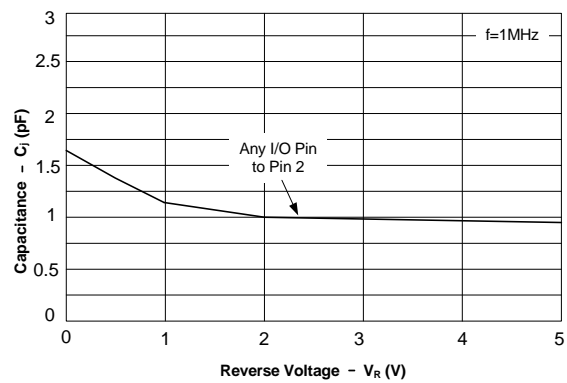

## Applications Information

### Device Connection Options for Protection of Four High-Speed Data Lines

This device is designed to protect data lines by clamping them to a fixed reference. When the voltage on the protected line exceeds the reference voltage the steering diodes are forward biased, conducting the transient current away from the sensitive circuitry. Data lines are connected at pins 1, 3, 4 and 6. Pin 2 should be connected directly to a ground plane. The path length is kept as short as possible to minimize parasitic inductance. The positive reference is connected at pin 5. The options for connecting the positive reference are as follows:

1. To protect data lines and the power line, connect pin 5 directly to the positive supply rail (VCC). In this configuration the data lines are referenced to the supply voltage. The internal TVS diode prevents over-voltage on the supply rail. See Figure 1.
2. In applications where the supply rail does not exit the system, the internal TVS may be used as the reference. In this case, pin 5 is not connected. The steering diodes will begin to conduct when the voltage on the protected line exceeds the working voltage of the TVS (plus one diode drop).
3. In applications where complete supply isolation is desired, the internal TVS is again used as the reference and VCC is connected to one of the I/O inputs. An example of this configuration is the protection of a SIM port. The Clock, Reset, I/O, and VCC lines are connected at pins 1, 3, 4, and 6. Pin 2 is connected to ground and pin 5 is not connected. See Figure 2.

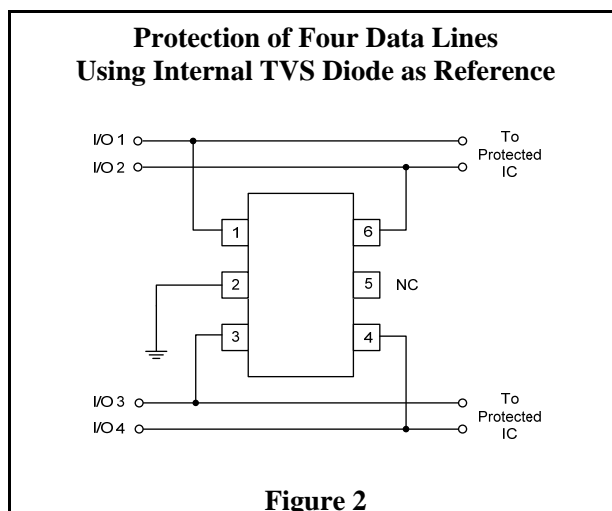
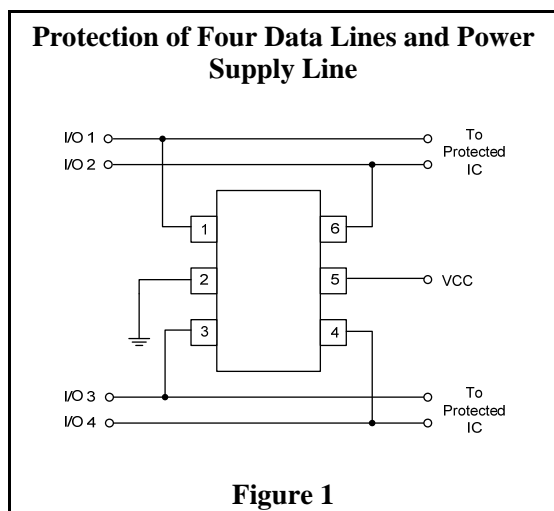

### Matte Tin Lead Finish

Matte tin has become the industry standard lead-free replacement for SnPb lead finishes. A matte tin finish is composed of 100% tin solder with large grains. Since the solder volume on the leads is small compared to the solder paste volume that is placed on the land pattern of the PCB, the reflow profile will be determined by the requirements of the solder paste. Therefore, these devices are compatible with both lead-free and SnPb assembly techniques. In addition, unlike other lead-free compositions, matte tin does not have any added alloys that can cause degradation of the solder joint.

## Package Information

### UM5204EEAF SC70-6/SC88/SOT363

## Outline Drawing

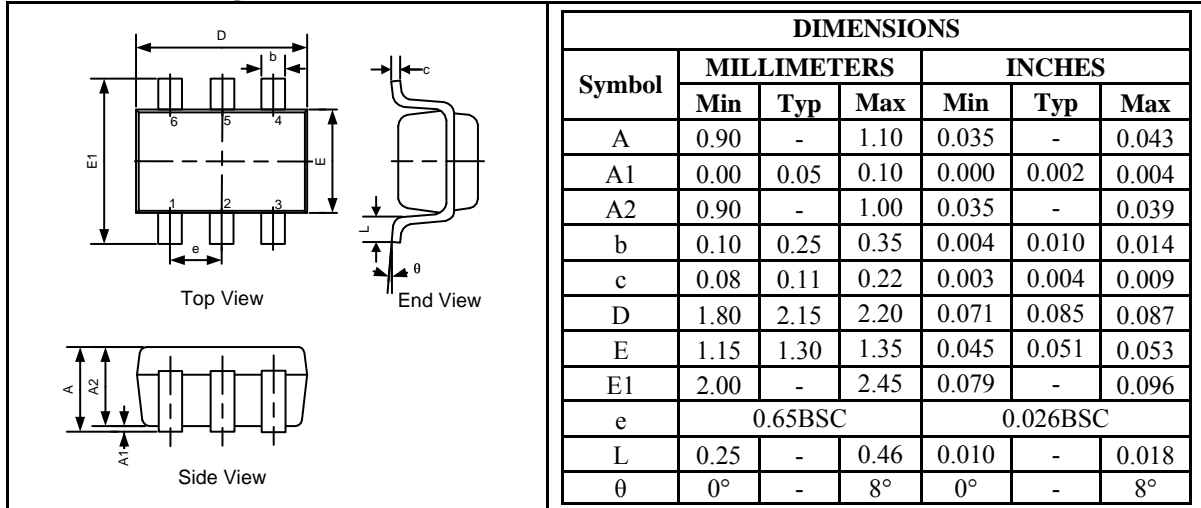

## Land Pattern

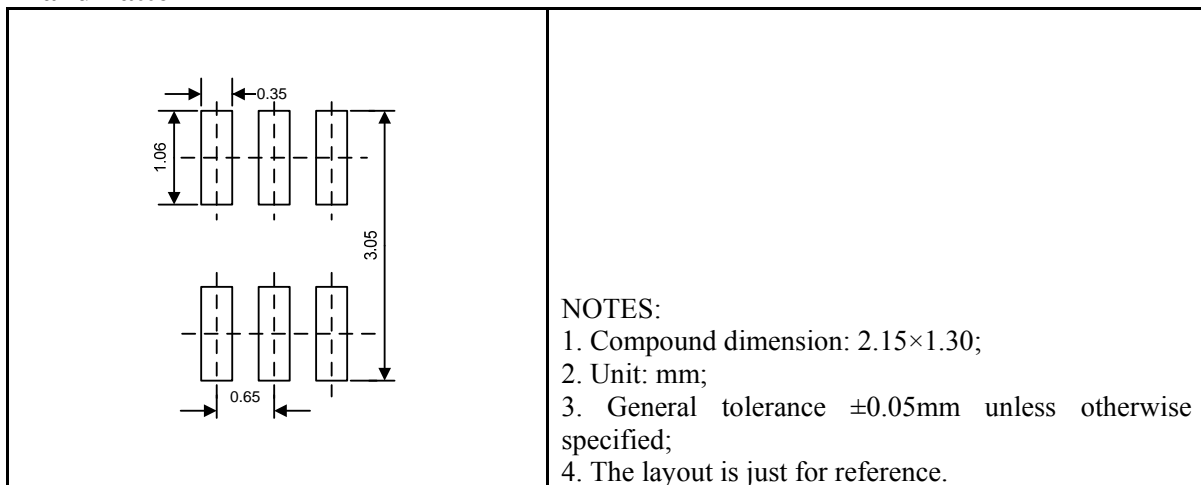

## Tape and Reel Orientation



## UM5204EEBF SC89-6/SOT563/SOT666

### Outline Drawing

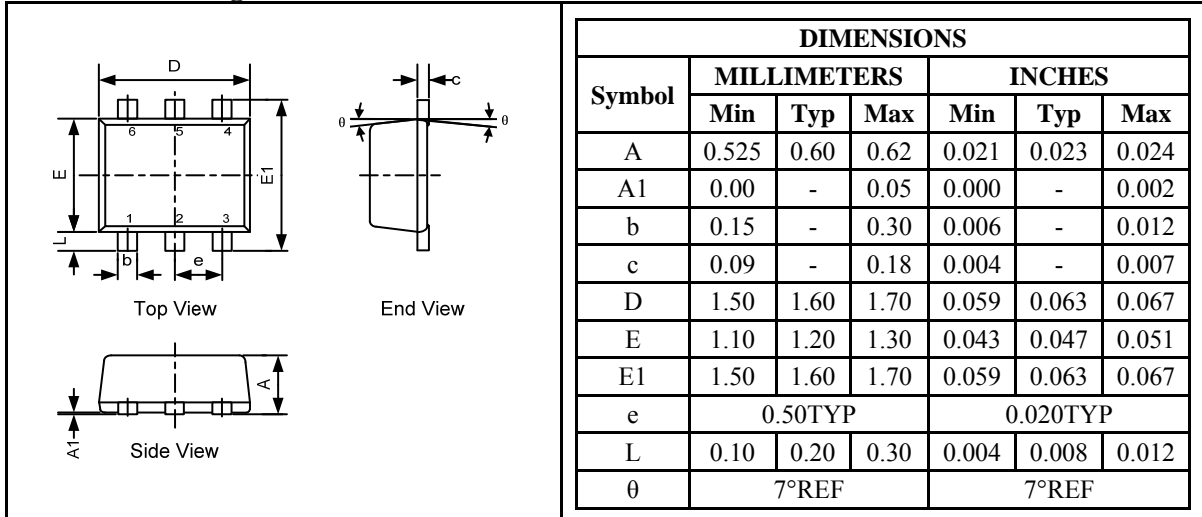

### Land Pattern

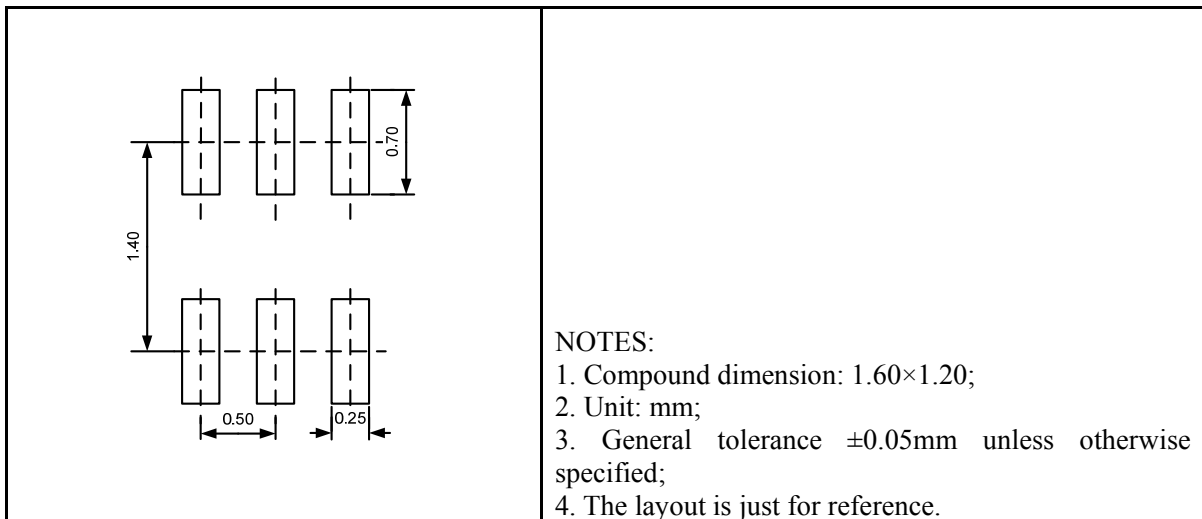

### Tape and Reel Orientation

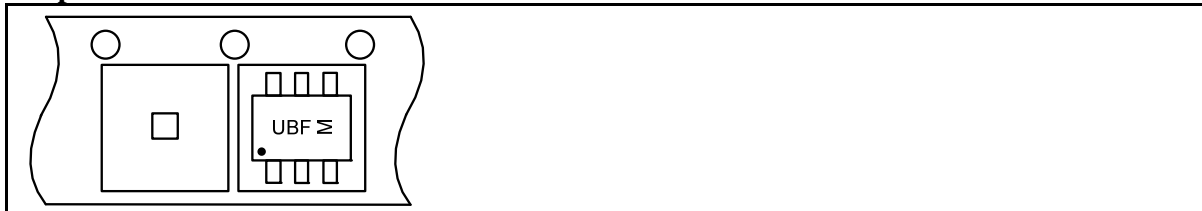

## UM5204EECF TSOP-6/SOT23-6

### Outline Drawing

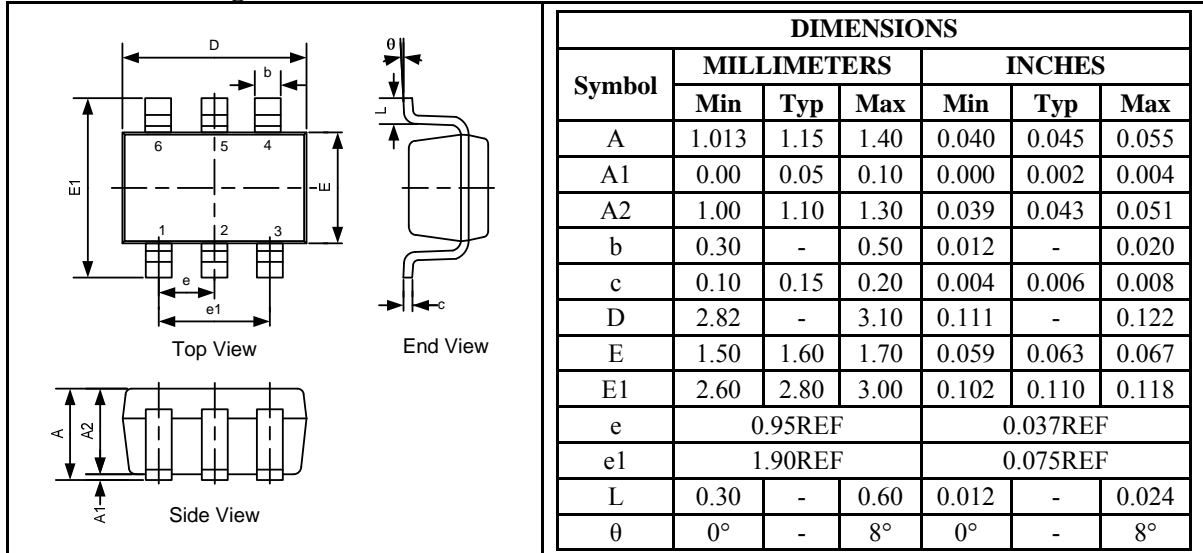

### Land Pattern

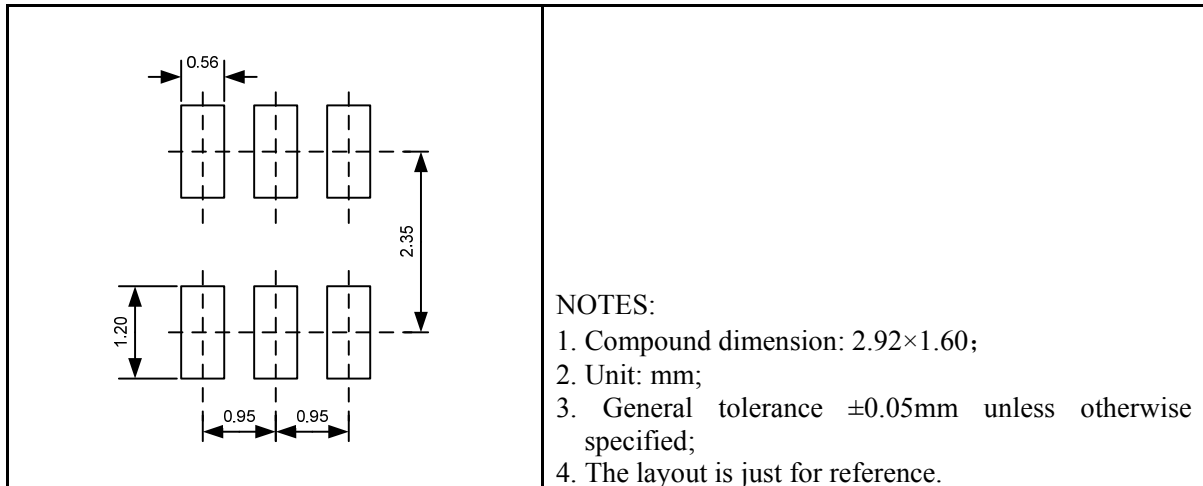

### Tape and Reel Orientation



---

## GREEN COMPLIANCE

Union Semiconductor is committed to environmental excellence in all aspects of its operations including meeting or exceeding regulatory requirements with respect to the use of hazardous substances. Numerous successful programs have been implemented to reduce the use of hazardous substances and/or emissions.

All Union components are compliant with the RoHS directive, which helps to support customers in their compliance with environmental directives. For more green compliance information, please visit:

[http://www.union-ic.com/index.aspx?cat\\_code=RoHSDeclaration](http://www.union-ic.com/index.aspx?cat_code=RoHSDeclaration)

## IMPORTANT NOTICE

The information in this document has been carefully reviewed and is believed to be accurate. Nonetheless, this document is subject to change without notice. Union assumes no responsibility for any inaccuracies that may be contained in this document, and makes no commitment to update or to keep current the contained information, or to notify a person or organization of any update. Union reserves the right to make changes, at any time, in order to improve reliability, function or design and to attempt to supply the best product possible.



Union Semiconductor, Inc

Add: Unit 606, No.570 Shengxia Road, Shanghai 201210

Tel: 021-51093966

Fax: 021-51026018

Website: [www.union-ic.com](http://www.union-ic.com)