

600mA, 1MHz, Synchronous Step-Up DC-DC Converter

UM3429S SOT23-6

General Description

The UM3429 is synchronous rectified, fixed frequency, step-up DC/DC converter series delivering high efficiency in low profile SOT23-6 package. It features true output load disconnection and adjustable output. With an internal NMOS switch, PMOS synchronous rectifier and high switching frequency of 1MHz, the UM3429 is capable of supplying 3.3V output at 100mA from a single AA cell input or 250mA from a 2-cell AA input using low profile inductors and ceramic capacitors.

Current mode PWM control with internal compensation as well as the synchronous rectifier and 1MHz high frequency lead to the fewest number of external parts needed thereby saving BOM cost and PCB area. At light load, UM3429 enters automatically into pulse skipping mode to keep high efficiency. An internal resistor will be connected to V_{IN} when the switch is idle that eliminates switch ringing and reduces EMI interference.

The device also features low shutdown current lower than $1\mu A$, inrush current limit.

Applications

- Digital Cameras
- LCD Bias Supplies
- Handheld Instruments
- Wireless Handsets
- GPS Receivers

Features

- Up to 92% Efficiency
- Output Load Disconnection
- Internal Synchronous Rectifier
- Low Voltage Start-Up: 0.85V
- Input Current Limit
- Pulse Skipping Mode Operation with Typical I_Q as $40\mu A$
- Shutdown Current Lower than $1\mu A$
- 1MHz Switching Frequency for Low Profile Inductor/Capacitor
- Input Voltage: 0.5V to 5.0V
- Output Voltage: 2.5V to 5.5V
- Anti-Ringing Control to Reduce EMI

Typical Application Circuit

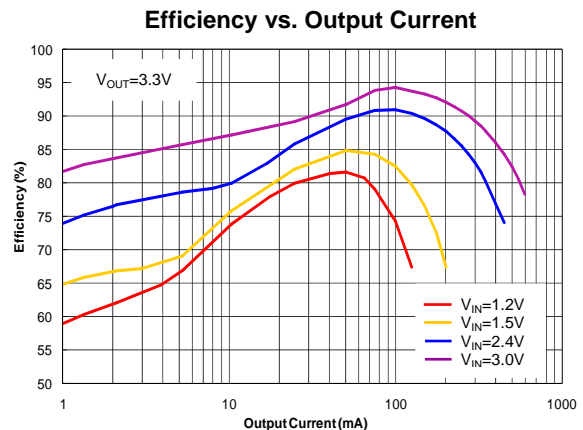
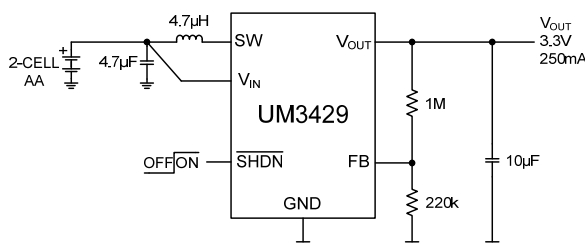

Pin Configurations

Top View

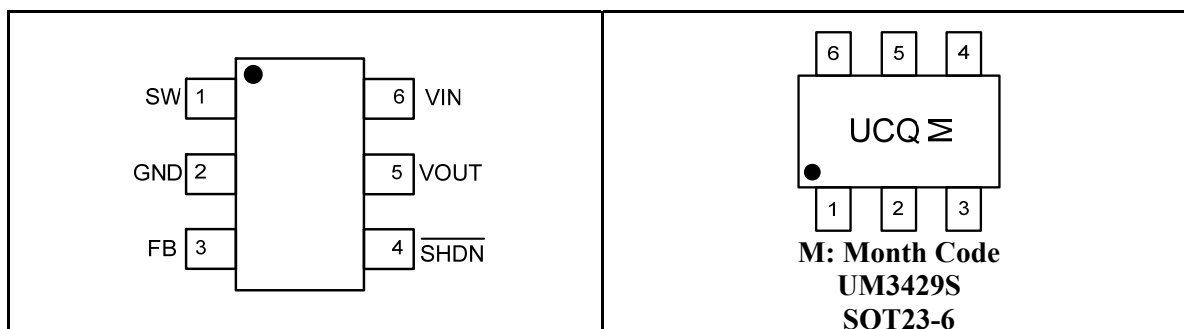

Pin Description

Pin Number	Symbol	Description
1	SW	Switch Pin. Connect external inductance to V_{IN} . Keep these PCB trace lengths as short and wide as possible.
2	GND	Ground. Provide a short direct PCB path between GND and the negative electrode of C_{OUT} and C_{IN} .
3	FB	Feedback Input Pin. Connect to the center point of the external resistor divider and set the output voltage by: $V_{OUT} = 0.6V \left(1 + \frac{R1}{R2} \right)$
4	\overline{SHDN}	Logic Controlled Shutdown Input. Low logic active. In shutdown mode, all functions are disabled drawing $<1\mu A$ supply current. Do not leave \overline{SHDN} floating.
5	VOUT	Output Voltage Sense Input and Drain of the Internal Synchronous Rectifier P-MOSFET. Bias is derived from V_{OUT} . Keep PCB trace length from V_{OUT} to the output filter capacitor(s) as short and wide as possible.
6	VIN	Battery Input Voltage. The device gets its start-up bias from V_{IN} . Once V_{OUT} exceeds V_{IN} , bias comes from V_{OUT} . Thus, once started, operation is completely independent from V_{IN} . Operation is only limited by the output power level and the battery's internal series resistance.

Ordering Information

Part Number	Packaging Type	Marking Code	Shipping Qty
UM3429S	SOT23-6	UCQ	3000pcs/7Inch Tape & Reel

Absolute Maximum Ratings (Note 1)

Symbol	Parameter	Value	Unit
V_{IN}	V_{IN} Supply Voltage	-0.3 to +6.0	V
V_{SW}	SW Voltage	-0.3 to +6.0	V
V_{FB}	FB Voltage	-0.3 to +6.0	V
$V_{\overline{SHDN}}$	\overline{SHDN} Voltage	-0.3 to +6.0	V
V_{OUT}	Output Voltage	-0.3 to +6.0	V
T_{OP}	Operating Temperature Range	-40 to +85	°C
T_{STG}	Storage Temperature Range	-65 to +150	°C
T_L	Maximum Lead Temperature (Soldering , 10s)	+260	°C

Note 1: Maximum ratings are those values beyond which device damage can occur. Maximum ratings applied to the device are individual stress limit values (not normal operating conditions) and are not valid simultaneously. If these limits are exceeded, device functional operation is not implied, damage may occur and reliability may be affected.

Electrical Characteristics

 ($V_{IN}=+1.2V$, $V_{OUT}=+3.3V$, $T_A=+25^{\circ}C$, unless otherwise noted.)

Parameter	Test Conditions	Min	Typ	Max	Unit
Minimum Start-up Voltage	$I_{LOAD}=1mA$, $V_{OUT}=0V$		0.85	1	V
Minimum Operating Voltage	$\overline{SHDN}=V_{IN}$ (Note 2)		0.5	0.65	V
Maximum Input Voltage		5			V
Adjustable Output Voltage Range		2.5		5	V
Feedback Voltage		0.595	0.6	0.605	V
Feedback Input Current	$V_{FB}=0.6V$		1	50	nA
Quiescent Current (Pulse Skipping Mode)	$V_{FB}=0.7V$, $V_{IN}=\overline{SHDN}$ (Note 3)		40		μA
Quiescent Current (Normal)	$V_{FB}=0.5V$, $V_{IN}=\overline{SHDN}$ (Note 3)		1.4		mA
Quiescent Current (Shutdown)	$\overline{SHDN}=0V$			1	μA
NMOS Leakage Current	$V_{SW}=5V$			0.5	μA
PMOS Leakage Current	$V_{SW}=5V$, $V_{OUT}=0V$			0.5	μA
NMOS On-Resistance			0.4		Ω
PMOS On-Resistance			0.5		Ω
NMOS Current limit		600	850		mA
Pulse Skipping Mode Operation Current Threshold	$L=4.7\mu H$		5		mA
Max Duty Cycle		80	90		%
Switching Frequency		0.8	1	1.2	MHz
\overline{SHDN} Input High		1			V
\overline{SHDN} Input Low				0.35	V
\overline{SHDN} Input Current	$\overline{SHDN}=5.5V$		0.01	1	μA

Note 2: Minimum V_{IN} operation after start-up is only limited by the battery's ability to provide the necessary power as it enters a deeply discharged state.

Note 3: Pulse skipping mode and normal operation I_Q is measured at V_{OUT} . The chip is in the open loop status and the inductor should not be soldered.

Typical Operating Characteristics

($C_{IN}=4.7\mu F$, $C_{OUT}=10\mu F$, $L=4.7\mu H$, $T_A=25^\circ C$, unless otherwise specified)

Efficiency vs. Output Current

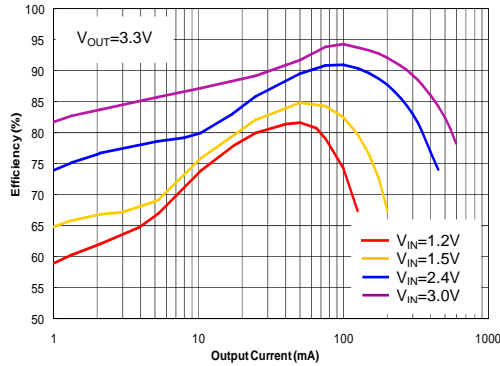

Efficiency vs. Output Current

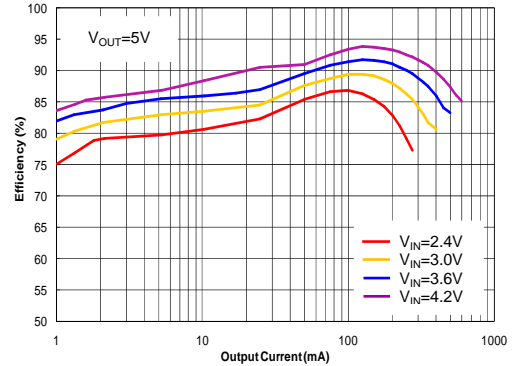

Output Voltage vs. Output Current

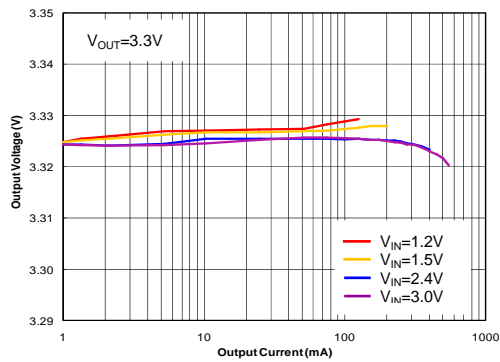

Output Voltage vs. Output Current

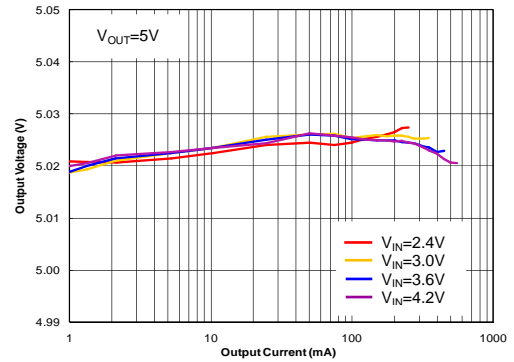

Efficiency vs. Temp

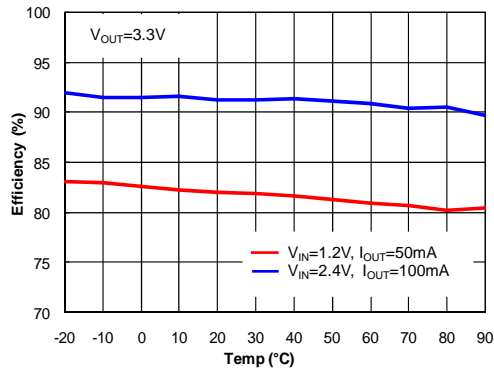

Output Voltage vs. Temp

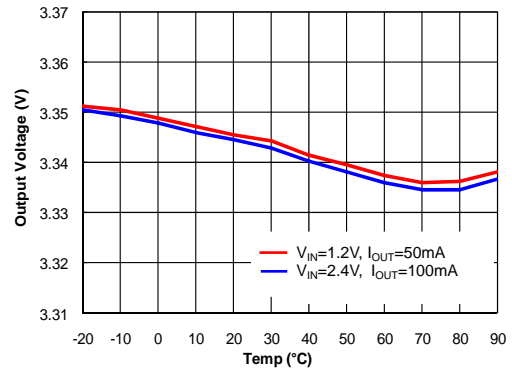

Minimum Start-up Voltage vs. Current

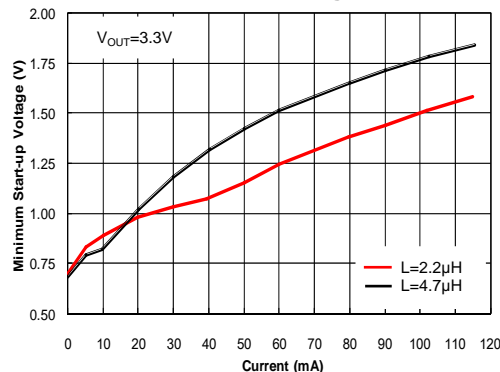

Pulse Skipping Mode Output Current Threshold vs. Input Voltage

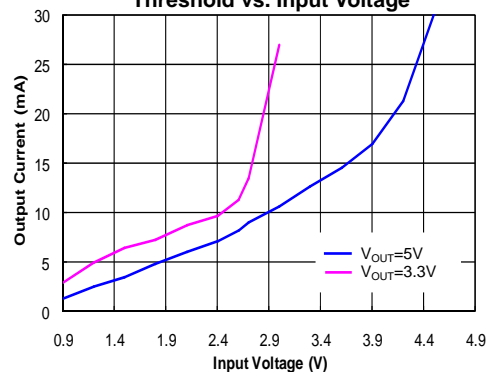

Typical Operating Characteristics (Continued)

($V_{IN}=1.5V$, $V_{OUT}=3.3V$, $C_{IN}=4.7\mu F$, $C_{OUT}=10\mu F$, $L=4.7\mu H$, $T_A=25^\circ C$, unless otherwise specified)

SW Pin Normal Mode Operation

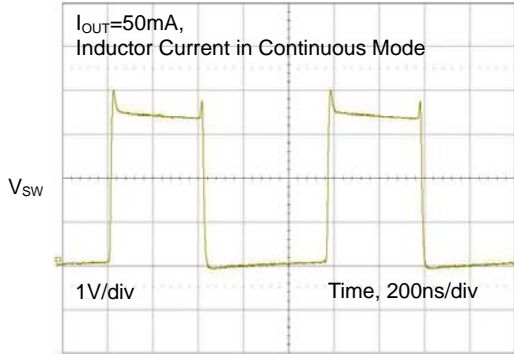

SW Pin Anti-Ringing Operation

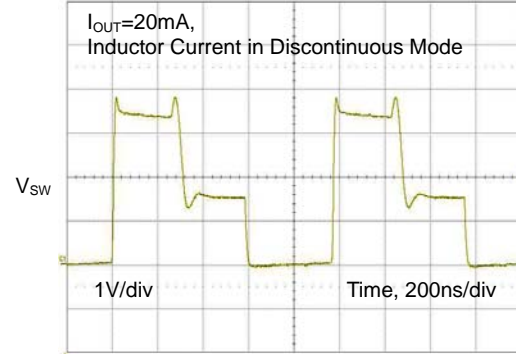

Line Transient Response

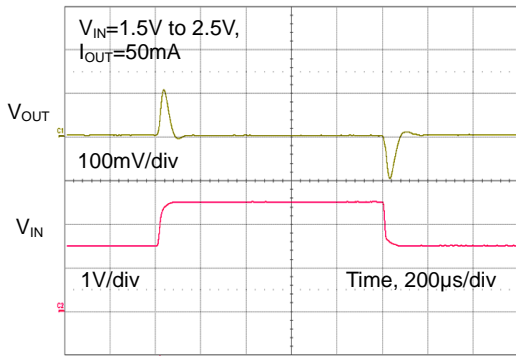

Load Transient Response

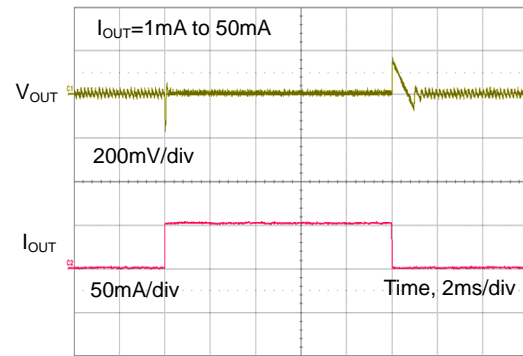

Pulse Skipping Mode Ripple

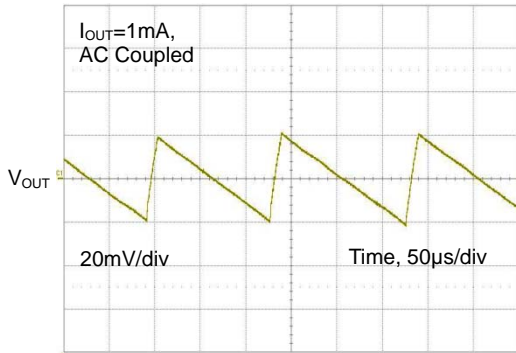

Ripple and Noise

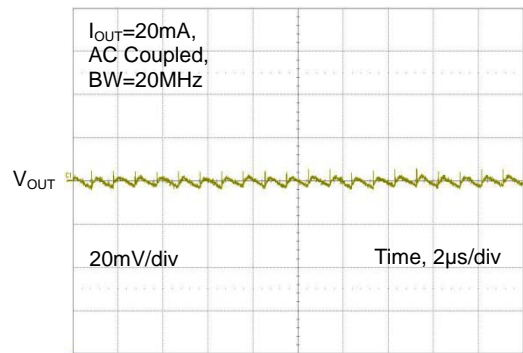

Ripple and Noise

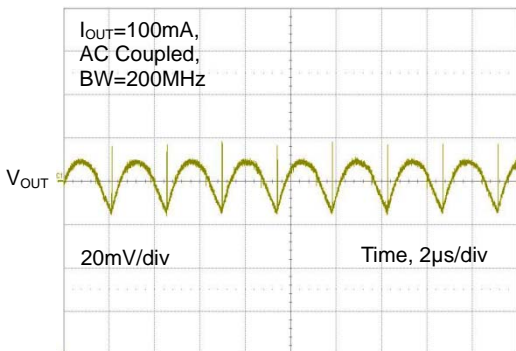

Ripple and Noise

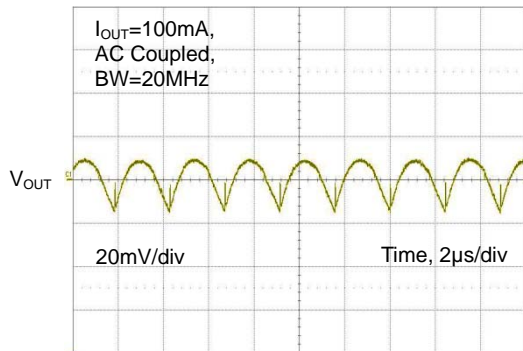

Block Diagram

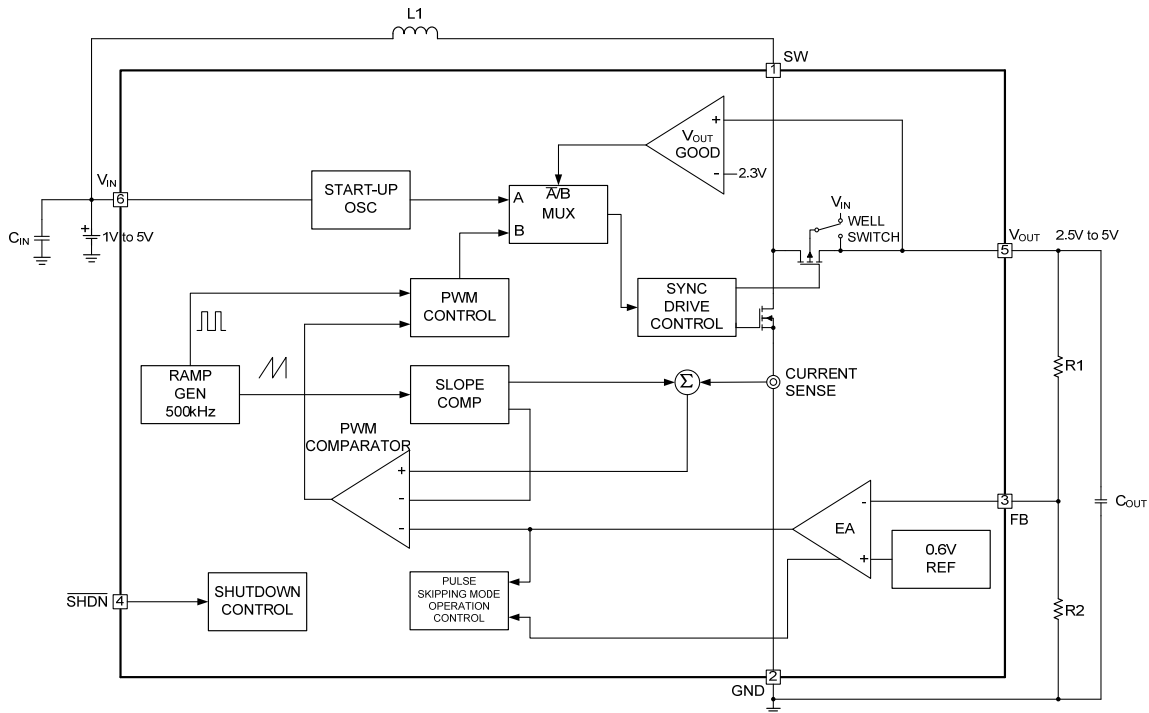

Function Description

The UM3429 is a synchronous rectified, 1MHz fixed frequency, step-up DC/DC converter in low profile SOT23-6 package. It features start-up voltage low to 0.85V, low $R_{DS(ON)}$ internal MOSFET switches, current mode PWM controller and 0.6V internal reference voltage. Refer to the Block Diagram for better understanding.

Low Voltage Start-up

The UM3429 has an independent start-up oscillator. When the input voltage rises to 0.85V, the oscillator starts up. The frequency and duty cycle of the oscillator will be set to a fixed one (Typically: the frequency is 275kHz and the duty is 67%). In this status, the chip is in the open loop operation.

The device gets its start-up bias from V_{IN} . Once V_{OUT} exceeds V_{IN} , bias comes from V_{OUT} . The chip is still in the open loop operation in this status.

When the output voltage rises to 2.3V, the chip will switch to closed loop. The chip enters normal operation then.

Anti-Ringing Control

An internal 150Ω resistor will be connected from SW to V_{IN} to damp resonant circuit formed by L and C_{SW} when the inductor current is in the discontinuous mode. That eliminates switch ringing and reduces EMI interference.

Pulse Skipping Mode Operation

At very light loads, the UM3429 automatically enters Pulse Skipping Mode. In the Pulse Skipping Mode, the inductor current may reach zero or reverse on each pulse. The PWM control loop will automatically skip pulses to maintain output regulation. That improves the efficiency of the converter and saves energy of the battery.

Output Disconnection

The UM3429 is designed to allow true output disconnection by eliminating body diode conduction of the internal PMOS rectifier. This allows V_{OUT} to go to 0V during shutdown, drawing zero current from the input source. This function is realized by the well switch that connects the substrate to V_{IN} . Please refer to the Block Diagram for better understanding.

Applications Information

Output Voltage Setting

The external resistor divider sets the output voltage. Choose R_2 around 300k Ω for optimal transient response and feedback leakage current. V_{OUT} is set by:

$$V_{OUT} = 0.6V \left(1 + \frac{R_1}{R_2} \right)$$

Inductor Selection

A 2.2 μ H to 4.7 μ H inductor with DC current rating at least 1A is recommended for most applications.

Larger values of inductance will allow greater output current capability by reducing the inductor ripple current. Increasing the inductance above 6.8 μ H will increase size while providing little improvement in output current capability.

For best efficiency, the inductor DC resistance shall be as small as possible to reduce the I^2R power losses. As the switching frequency is up to 1MHz, inductor losses are closely related to the magnetic core materials. High frequency ferrite core inductors are preferred to comparatively cheap powdered iron core ones. To minimize radiated noise, use a toroid, pot core or shielded bobbin inductor. See Table 1 for some suggested inductors and suppliers.

Table 1. Recommended Inductors

Part	L (μ H)	Max DCR (m Ω)	Height (mm)	Supplier
74404024022	2.2	80	1.2	Würth Elektronik www.we-online.com
74404024033	3.3	120	1.2	
74404024047	4.7	175	1.2	
74404024068	6.8	300	1.2	
74404032047	4.7	96	1.5	
74404032068	6.8	120	1.5	
CDRH3D16-4R7	4.7	105	1.8	Sumida www.sumida.com
CR43-4R7	4.7	109	3.5	
DS1608-472	4.7	60	2.9	Coilcraft www.coilcraft.com
DO1608C-472	4.7	90	2.9	
LQH32CN4R7M24	4.7	195	2.2	Murata www.murata.com
LQM21PN4R7MGHL	4.7	275	0.9	

Input and Output Capacitor Selection

Low ESR capacitors should be used to minimize the output voltage ripple, input switching noise and the peak current drawn from the battery. Multilayer ceramic capacitors are an excellent choice as they have extremely low ESR and are available in small footprints. X5R and X7R dielectric materials are recommended.

A 4.7 μ F to 10 μ F input and output capacitor is sufficient for most applications. To minimize the output voltage ripple and improve the transient response, an output capacitor up to 22 μ F or larger can be used. Table 2 below shows a list of several ceramic capacitor suppliers.

Table 2. Recommended Capacitor Suppliers Information

Supplier	Website
AVX	www.avxcorp.com
Murata	www.murata.com
Fenghua	www.china-fenghua.com
Samsung Electro-Mechanics	www.samsungsem.com

Layout Guidance

When laying out the PC board, the following suggestions should be taken to ensure proper operation of the UM3429.

1. Consideration should be taken first to place C_{OUT} as closely as possible to the V_{OUT} and GND pins.
2. The power traces, including the GND, SW, V_{IN} and V_{OUT} should be kept short, direct and wide to allow large current flow.
3. Connect the input capacitor C_{IN} to the GND pin as closely as possible to get good power filter effect and reduce ground bounce.
4. Keep the switching node away from the sensitive FB node.
5. Do not trace signal line under inductor.
6. Keep the GND plane under the converter as complete as possible in double-sided PCB board.

Package Information

UM3429S: SOT23-6

Outline Drawing

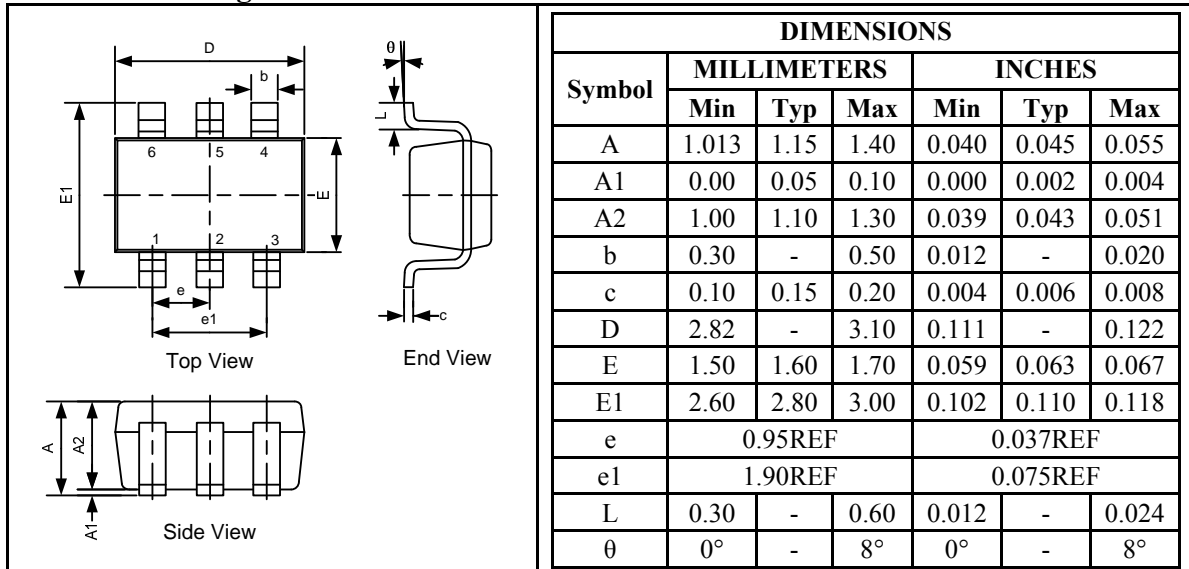

Land Pattern

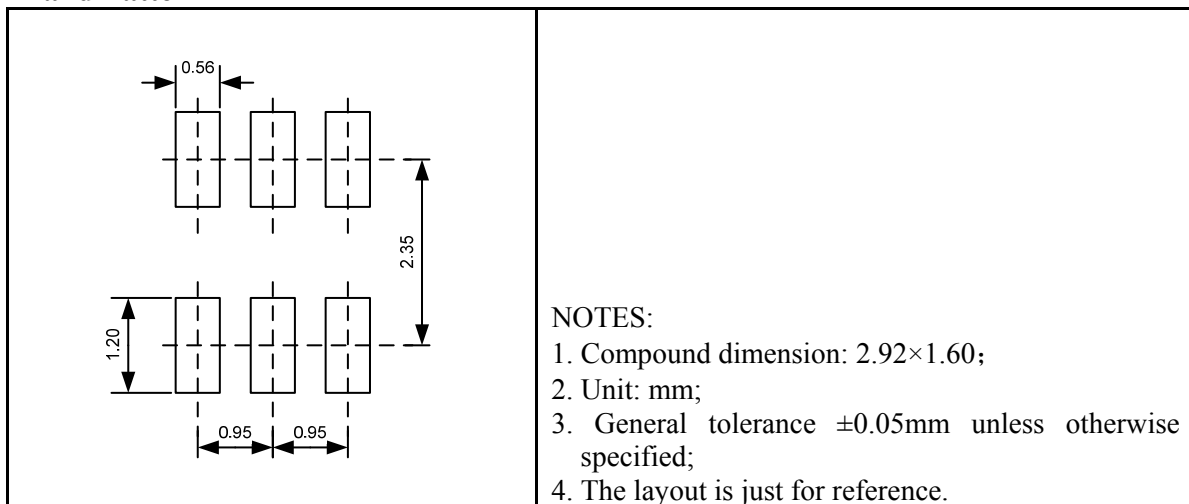

Tape and Reel Orientation



GREEN COMPLIANCE

Union Semiconductor is committed to environmental excellence in all aspects of its operations including meeting or exceeding regulatory requirements with respect to the use of hazardous substances. Numerous successful programs have been implemented to reduce the use of hazardous substances and/or emissions.

All Union components are compliant with the RoHS directive, which helps to support customers in their compliance with environmental directives. For more green compliance information, please visit:

http://www.union-ic.com/index.aspx?cat_code=RoHSDeclaration

IMPORTANT NOTICE

The information in this document has been carefully reviewed and is believed to be accurate. Nonetheless, this document is subject to change without notice. Union assumes no responsibility for any inaccuracies that may be contained in this document, and makes no commitment to update or to keep current the contained information, or to notify a person or organization of any update. Union reserves the right to make changes, at any time, in order to improve reliability, function or design and to attempt to supply the best product possible.