Single Supply RS-232 Transceivers**UM3232BEEUE TSSOP16****UM3232BEESE SOP16****UM3232BEEAE SSOP16****General Description**

The UM3232B is 3.3V powered RS-232 transceiver intended for portable or hand-held applications. The UM3232B has two drivers/two receivers. The device features low power consumption, high data-rate capability and enhanced ESD protection. The ESD rating of all transmitter outputs and receiver inputs is $\pm 8\text{kV}$ for human body mode, and $\pm 15\text{kV}$ for and IEC61000-4-2 air discharge methods, and $\pm 8\text{kV}$ for IEC61000-4-2 contact discharge methods. The logic I/O pins are protected to $\pm 2\text{kV}$ for human body mode.

Small footprint, low profile package and the use of small $0.1\mu\text{F}$ capacitors ensure board space savings as well. Data rates greater than 500kbps are guaranteed at worst case load conditions. This family is fully compatible with 3.3V-only systems, mixed 3.3V and 5.0V systems and 5.0V-only systems.

Applications

- Industrial Automation Equipments
- Battery-Powered Equipments
- Hand-Held Equipments
- POS Terminals

Features

- Meets True EIA/TIA-232-F Standards from a +3.0V to +5.5V Power Supply
- Enhanced ESD Specifications:
 - $\pm 8\text{kV}$ Human Body Mode
 - $\pm 15\text{kV}$ IEC61000-4-2 Air Discharge Mode
 - $\pm 8\text{kV}$ IEC61000-4-2 Contact Discharge Mode
- 500kbps Minimum Transmission Rate
- Guaranteed $30\text{V}/\mu\text{s}$ Max Slew Rate
- Latch-Up Performance Exceeds 200mA

Pin Configurations

Top View

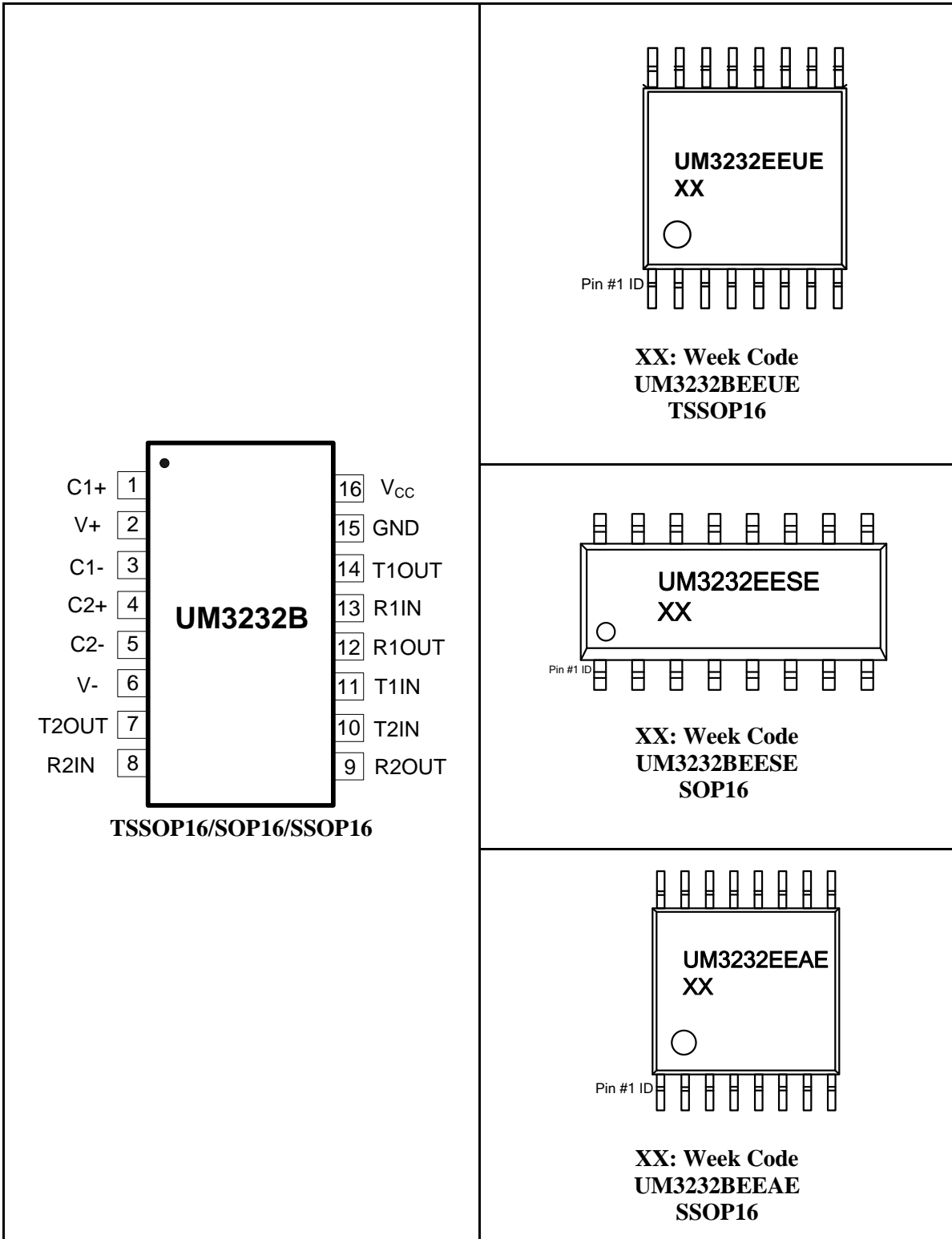

Pin Description

| Pin No. | Pin Name | Function |
|---------|-----------------|---|
| 1 | C1+ | Positive Terminals of Voltage-Doubler Charge Pump Capacitor |
| 2 | V+ | Positive Voltage Generated by the Charge Pump |
| 3 | C1- | Negative Terminals of Voltage-Doubler Charge Pump Capacitor |
| 4 | C2+ | Positive Terminals of Inverting Charge Pump Capacitor |
| 5 | C2- | Negative Terminals of Inverting Charge Pump Capacitor |
| 6 | V- | Negative Voltage Generated by the Charge Pump |
| 7, 14 | T_OUT | RS-232 Driver Outputs |
| 8, 13 | R_IN | RS-232 Receiver Inputs |
| 9, 12 | R_OUT | RS-232 Receiver Outputs |
| 10, 11 | T_IN | RS-232 Driver Inputs |
| 15 | GND | Ground |
| 16 | V _{CC} | +3.0V to +5.5V Supply Voltage Input |

Ordering Information

| Part Number | Temp. Range | Mark Code | Package Type | Shipping Qty |
|-------------|------------------|------------|--------------|-----------------------------|
| UM3232BEEUE | -40 °C to +85 °C | UM3232EEUE | TSSOP16 | 3000pcs/13 Inch Tape & Reel |
| UM3232BEESE | -40 °C to +85 °C | UM3232EESE | SOP16 | 2500pcs/13 Inch Tape & Reel |
| UM3232BEEAE | -40 °C to +85 °C | UM3232EEAE | SSOP16 | 2000pcs/13 Inch Tape & Reel |

Absolute Maximum Ratings (Note 1)

| Symbol | Parameter | Value | Unit | |
|-----------|---|--------------------------------|------------------|----|
| V_{CC} | Supply Voltage on V_{CC} | -0.3 to +6 | V | |
| V_+ | Voltage on V_+ | $(V_{CC}-0.3)$ to +7.5 | V | |
| V_- | Voltage on V_- | -7.5 to +0.3 | V | |
| T_{IN} | Voltage on T_{IN} | -0.3 to $(V_{CC}+0.3)$ | V | |
| R_{IN} | Voltage on R_{IN} | ± 25 | V | |
| T_{OUT} | Voltage on T_{OUT} | $(V_- - 0.3)$ to $(V_+ + 0.3)$ | V | |
| R_{OUT} | Voltage on R_{OUT} | -0.3 to $(V_{CC} + 0.3)$ | V | |
| | Short-Circuit Duration, T_{OUT} | Continuous | | |
| P_D | Continuous Power Dissipation at $T_A = 70^\circ\text{C}$ | TSSOP16 | 754 | mW |
| | | SOP16 | 696 | |
| | | SSOP16 | 775 | |
| T_A | Operating Temperature Range | -40 to +85 | $^\circ\text{C}$ | |
| T_J | Junction Temperature Range | -40 to +125 | $^\circ\text{C}$ | |
| T_{STG} | Storage Temperature Range | -65 to +150 | $^\circ\text{C}$ | |
| T_L | Maximum Lead Temperature for Soldering 10 Seconds | +300 | $^\circ\text{C}$ | |

Note 1: Stresses beyond those listed under “Absolute Maximum Ratings” may cause permanent damage to the device. These are stress ratings only, and functional operation of the device at these or any other conditions beyond those indicated in the operational sections of the specifications is not implied. Exposure to absolute maximum rating conditions for extended periods may affect device reliability.

Electrical Characteristics

($V_{CC}=+3.0V$ to $+5.5V$, $C1- C4=0.1\mu F$, $T_A=T_{MIN}$ to T_{MAX} , unless otherwise noted. Typical values are at $T_A=25^\circ C$)

| Parameter | Symbol | Conditions | Min | Typ | Max | Unit | |
|---|----------|--|-------------------------------|-----------|----------|------------|----|
| DC CHARACTERISTICS ($V_{CC}=+3.3V$ or $+5V$, $T_A=25^\circ C$) | | | | | | | |
| V_{CC} Supply Current | I_{CC} | No Load | | | 2.5 | mA | |
| LOGIC INPUTS | | | | | | | |
| Input Leakage Current | | T_{IN} | | | ± 1 | μA | |
| Input Threshold Low | V_{IL} | T_{IN} | $V_{CC}=3.3V$ | | 0.8 | V | |
| | | | $V_{CC}=5.0V$ | | 0.8 | | |
| Input Threshold High | V_{IH} | T_{IN} | $V_{CC}=3.3V$ | 1.6 | | V | |
| | | | $V_{CC}=5.0V$ | 2.2 | | | |
| Transmitter Input Hysteresis | | | $V_{CC}=3.3V$ | | 0.2 | V | |
| | | | $V_{CC}=5.0V$ | | 0.15 | | |
| RECEIVER OUTPUTS | | | | | | | |
| Output Voltage Low | V_{OL} | | $V_{CC}=3.3V, I_{OUT}=1.6mA$ | | 0.8 | V | |
| | | | $V_{CC}=5.0V, I_{OUT}=1.6mA$ | | 0.8 | | |
| Output Voltage High | V_{OH} | | $V_{CC}=3.3V, I_{OUT}=-1.0mA$ | 2.8 | | V | |
| | | | $V_{CC}=5.0V, I_{OUT}=-1.0mA$ | 4.4 | | | |
| RECEIVER INPUTS | | | | | | | |
| Input Voltage Range | | | -20 | | 20 | V | |
| Input Threshold Low | | $T_A=+25^\circ C$ | $V_{CC}=3.3V$ | 0.8 | 1.15 | V | |
| | | | $V_{CC}=5.0V$ | 0.8 | 1.55 | | |
| Input Threshold High | | $T_A=+25^\circ C$ | $V_{CC}=3.3V$ | | 1.35 | V | |
| | | | $V_{CC}=5.0V$ | | 1.75 | | |
| Input Hysteresis | | | | 0.2 | | V | |
| Input Resistance | | $T_A=+25^\circ C$ | 3 | 5 | 7 | k Ω | |
| TRANSMITTER OUTPUTS | | | | | | | |
| Output Voltage Swing | | All Drivers Loaded with $3k\Omega$ to Ground | ± 5.0 | ± 6.0 | | V | |
| Output Short-Circuit Current | | Short to V_{CC} , GND or Other TXD Pin | $V_{CC}=3.3V$ | | ± 30 | ± 60 | mA |
| | | | $V_{CC}=5.0V$ | | ± 40 | ± 60 | mA |

Electrical Characteristics (Continued)

($V_{CC}=+3.0V$ to $+5.5V$, $C1- C4=0.1\mu F$, $T_A=T_{MIN}$ to T_{MAX} , unless otherwise noted. Typical values are at $T_A=25^\circ C$)

| Parameter | Symbol | Conditions | Min | Typ | Max | Unit |
|--|-----------------------|--|-----|-----------|-----|-----------|
| TIMING CHARACTERISTICS | | | | | | |
| Maximum Data Rate | | $R_L=3k\Omega$ to $7k\Omega$, $C_L=50pF$ to $1000pF$, One Transmitter Switching | 500 | | | kbps |
| Receiver Propagation Delay | t_{PLH} , t_{PHL} | $C_L=150pF$ Figure 1 | | 0.15 | | μs |
| Receiver Skew | $ t_{PHL}-t_{PLH} $ | | | | 0.1 | μs |
| Transmitter Propagation Delay | t_{PLH} , t_{PHL} | $R_L=3k\Omega$, $C_L=2500pF$, All Transmitters Loaded Figure 1 | | 0.9 | | μs |
| Transmitter Skew | $ t_{PHL}-t_{PLH} $ | | | | 0.1 | μs |
| Transition-Region Slew Rate | | $T_A=+25^\circ C$, $V_{CC}=3.3V$, $R_L=3k\Omega$ to $7k\Omega$, $C_L=50pF$ to $1000pF$, Measured from $-3V$ to $+3V$ or $+3V$ to $-3V$, Figure 1 | 2.5 | 12 | 28 | $V/\mu s$ |
| ESD AND LATCH UP PERFORMANCE | | | | | | |
| R_IN, T_OUT ESD-Protection Voltage | | Human Body Model | | ± 8 | | kV |
| | | IEC61000-4-2, Contact Discharge | | ± 8 | | |
| | | IEC61000-4-2, Air-Gap Discharge | | ± 15 | | |
| Logic Pin ESD-Protection Voltage | | Human Body Model | | ± 2 | | kV |
| Latch Up Performance | | JEDEC Standard No.78D | | ± 200 | | mA |

Detailed Description

Dual Charge-Pump Voltage Converter

The UM3232B's internal power supply consists of a regulated dual charge pump and provides output the maxim voltages of +7V (doubling charge pump) and -7V (inverting charge pump) over the +3.0V to +5.5V V_{CC} range. The charge pump operates in discontinuous mode; if the output voltages are less than 7V, the charge pump is enabled, and if the output voltages exceed 7V, the charge pump is disabled. The charge pumps require only four small, external 0.1 μ F capacitors for the voltage doubler and inverter functions (see Figure 2).

RS-232 Transmitters

The transmitters are inverting level translators that translate TTL/CMOS inputs to EIA/TIA-232 output levels. All UM3232B transmitters guarantee a 500kbps data rate for full load conditions (3k Ω and 1000pF). Transmitters can be paralleled to drive multiple receivers. When T_IN is not driven, UM3232B's T_IN logic level is on hold.

RS-232 Receivers

The receivers convert RS-232 signals to CMOS output levels and accept inputs up to ± 20 V while presenting the required 3k Ω to 7k Ω input impedance.

± 15 kV ESD Protection

All pins on UM3232B devices include ESD protection structures, but the family incorporates advanced structures which allow the RS-232 pins (transmitter outputs and receiver inputs) to survive ESD events up to ± 15 kV. The RS-232 pins are particularly vulnerable to ESD damage because they are typically connected to an exposed port on the exterior of the finished product. The ESD structures withstand high ESD in all states: normal operation and powered down. After an ESD event, circuits keep working without latch up. ESD protection can be tested in various ways; the transmitter outputs and receiver inputs are characterized for protection to the following limits: ± 8 kV using the Human Body Model, ± 8 kV using the Contact Discharge method specified in IEC61000-4-2, ± 15 kV using the Air-Gap Discharge method specified in IEC61000-4-2. The logic pins are characterized for protection to the following limit: ± 2 kV using the Human Body Model.

Test Circuits

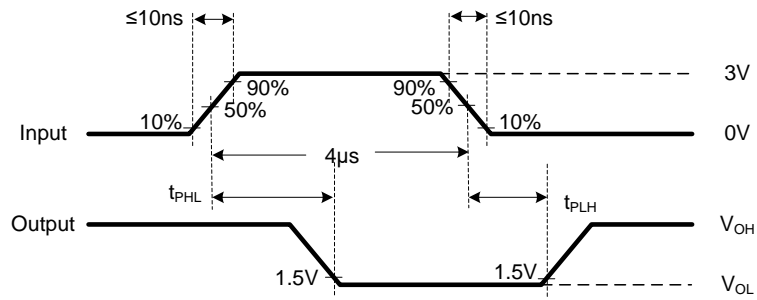
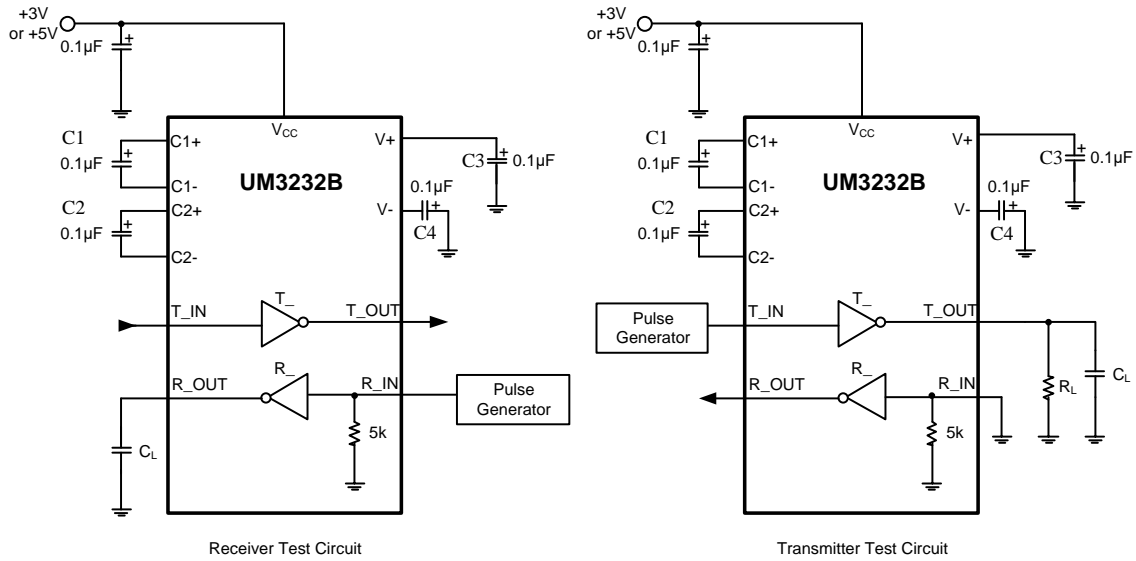

Receiver Waveforms

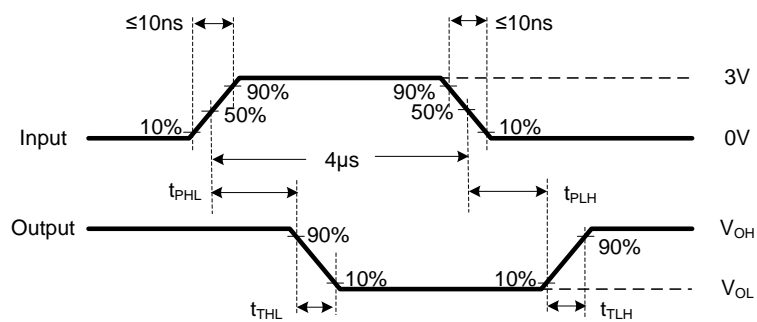

Transmitter Waveforms

Figure 1

Typical Operating Circuits

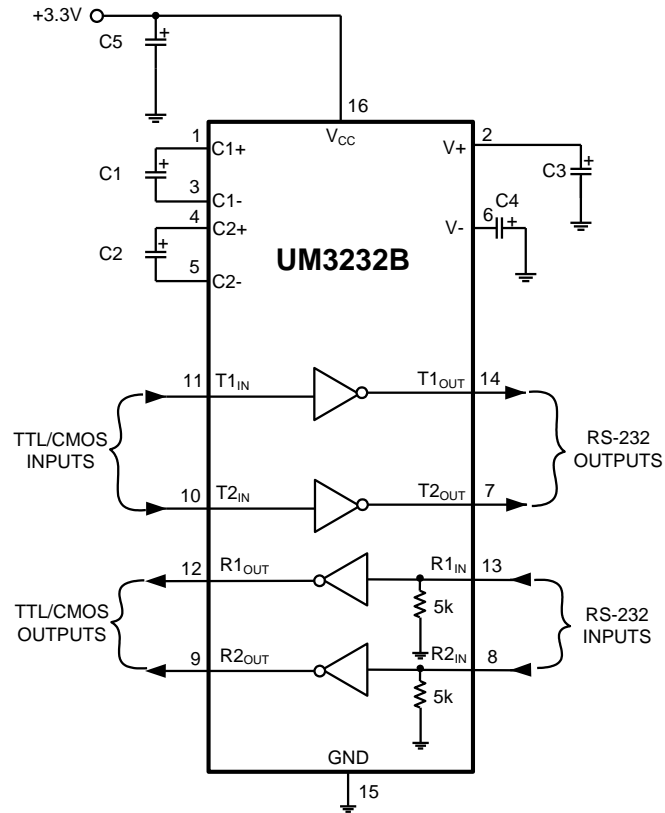
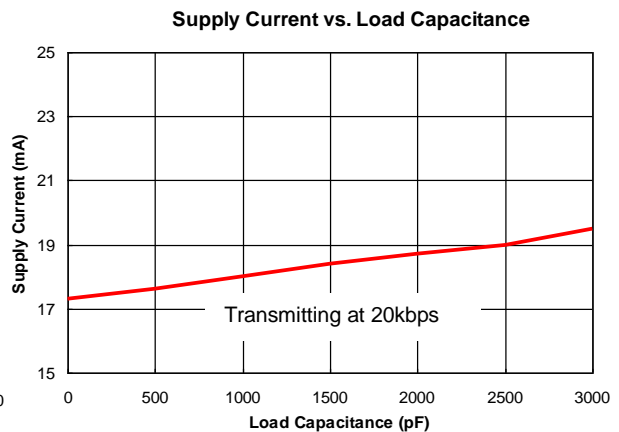
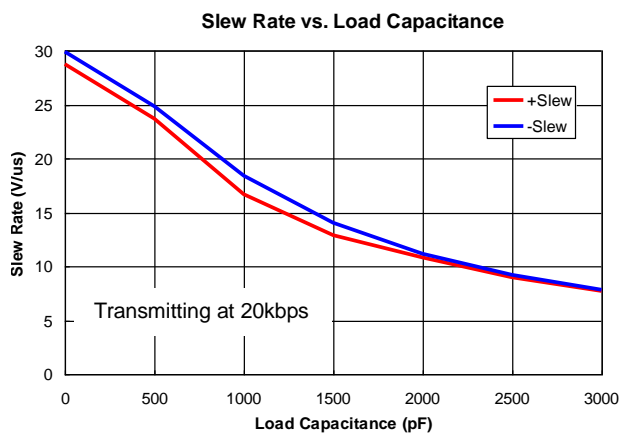
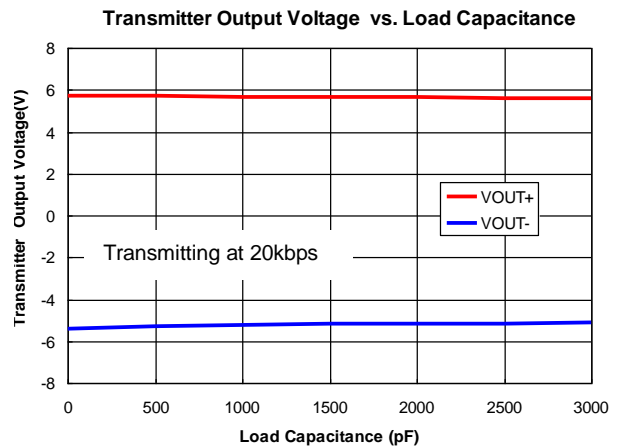
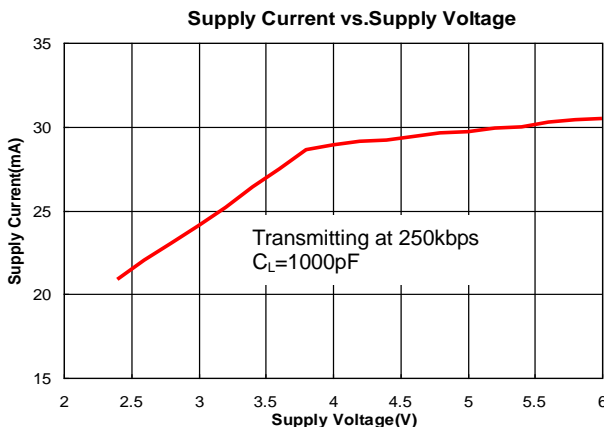
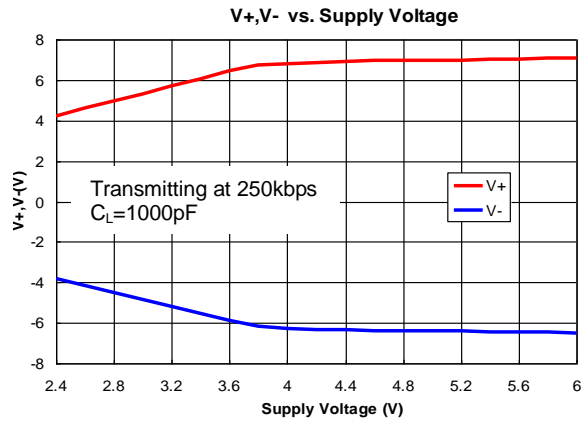
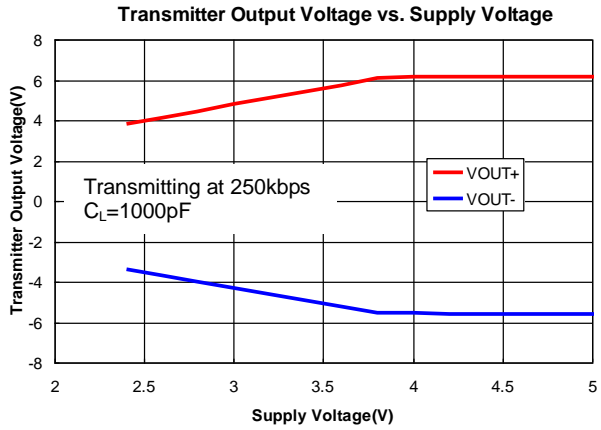

Figure 2

Typical Operating Characteristics

($V_{CC}=+3.3V$, 250kbps data rate, $0.1\mu F$ capacitors, all transmitters loaded with $3k\Omega$ and C_L , $T_A=25^\circ C$, unless otherwise noted.)



Applications Information

Capacitor Selection

The capacitor type used for C1–C4 is not critical for proper operation; polarized or non-polarized capacitors can be used. The charge pump requires 0.1 μ F capacitors for 3.3V operation. Increasing the capacitor values (e.g. by a factor of 2) reduces ripples on the transmitter outputs and slightly reduces power consumption. C2, C3 and C4 can be increased without changing C1's value. When using the minimum required capacitor values, make sure the capacitor value does not degrade excessively with temperature. If in doubt, use capacitors with a larger nominal value. The capacitor's equivalent series resistance (ESR), which usually rises at low temperatures, influences the amount of ripples on V+ and V- output voltages.

The following table shows some recommended minimum required pump capacitor values for different input voltage ranges.

| Minimum Required Pump Capacitor Value | |
|---------------------------------------|---|
| Input Voltage V_{CC} | Charge Pump Capacitor Value for UM3232B |
| 3.0V to 3.6V | C1–C4=0.1 μ F |
| 3.0V to 5.5V | C1–C4=0.47 μ F |

Power Supply Decoupling

In most circumstances, a 0.1 μ F V_{CC} bypass capacitor is adequate. In applications sensitive to power-supply noise, use a capacitor of the same value as charge pump capacitor C1. Connect bypass capacitors to the IC as close as possible.

Interconnection with 3V and 5V Logic

The UM3232B can directly interface with various 3V and 5V logic families, including ACT and HCT CMOS.

Package Information

UM3232BEEUE TSSOP16

Outline Drawing

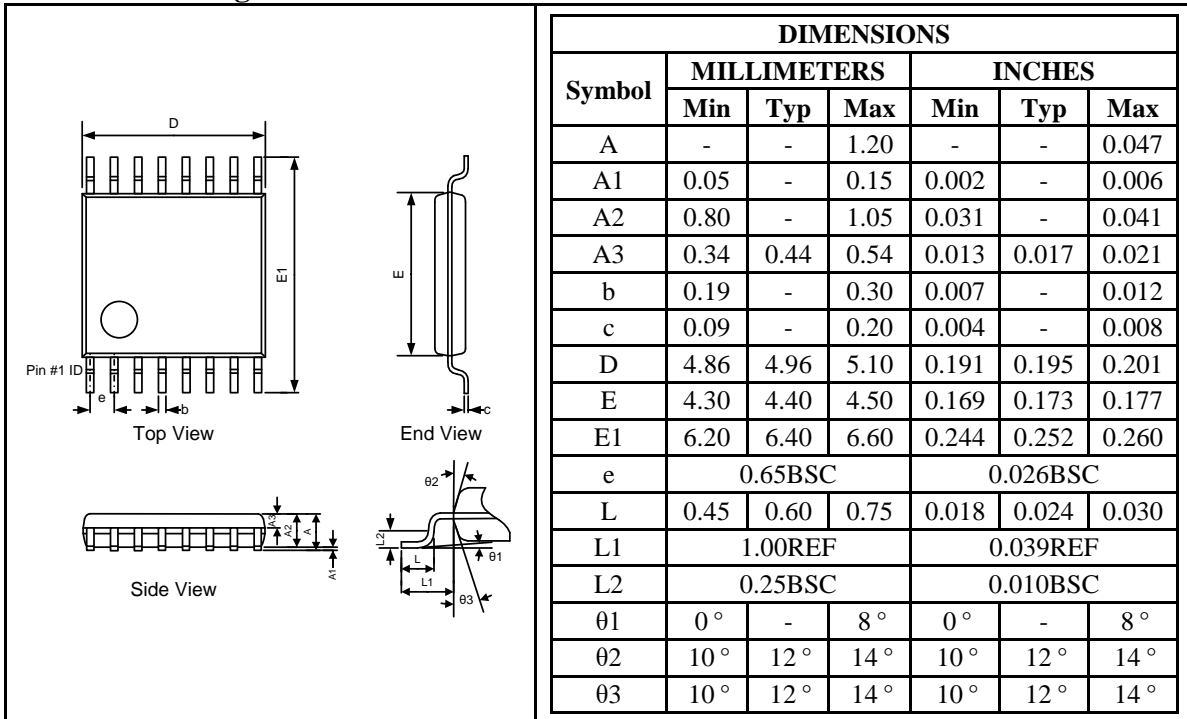

Land Pattern

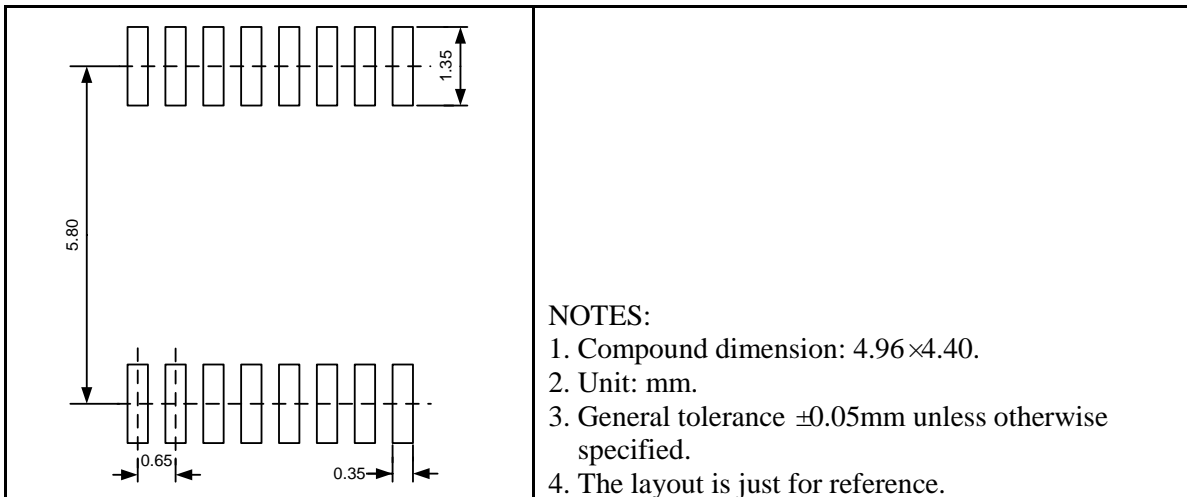

Tape and Reel Orientation

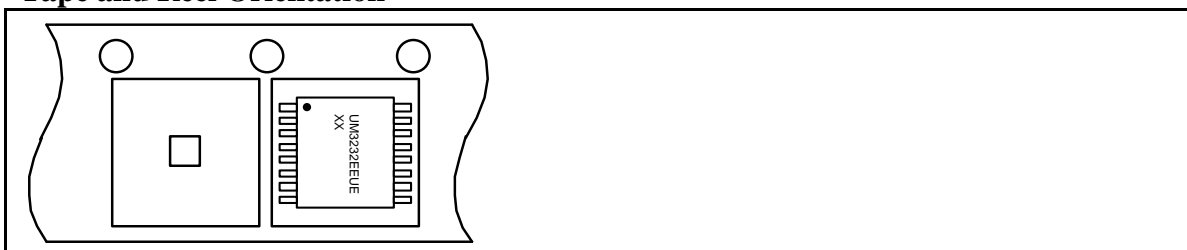

UM3232BEESE SOP16

Outline Drawing

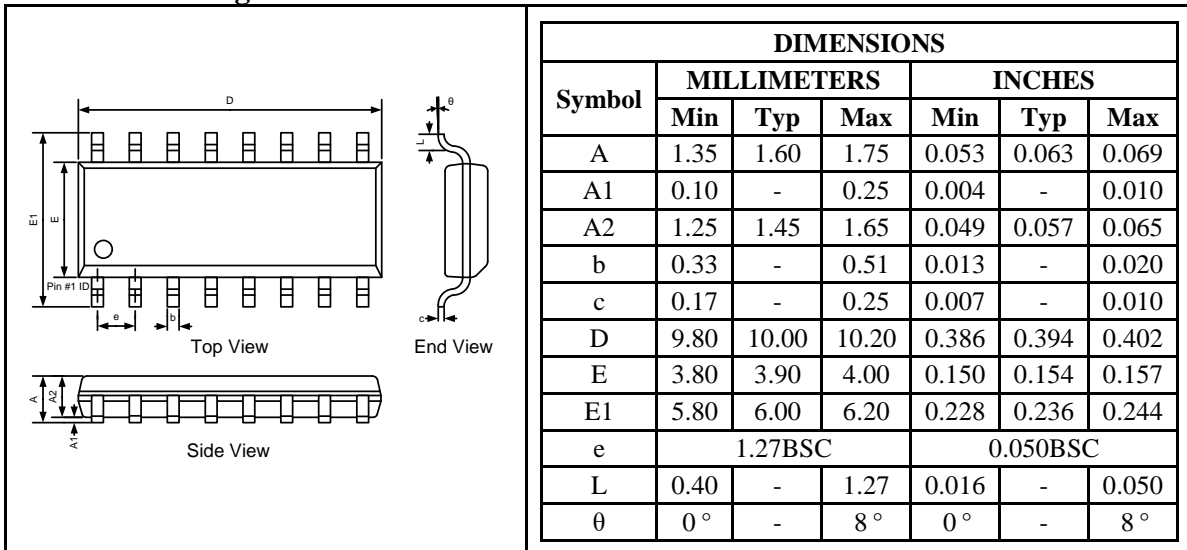

Land Pattern

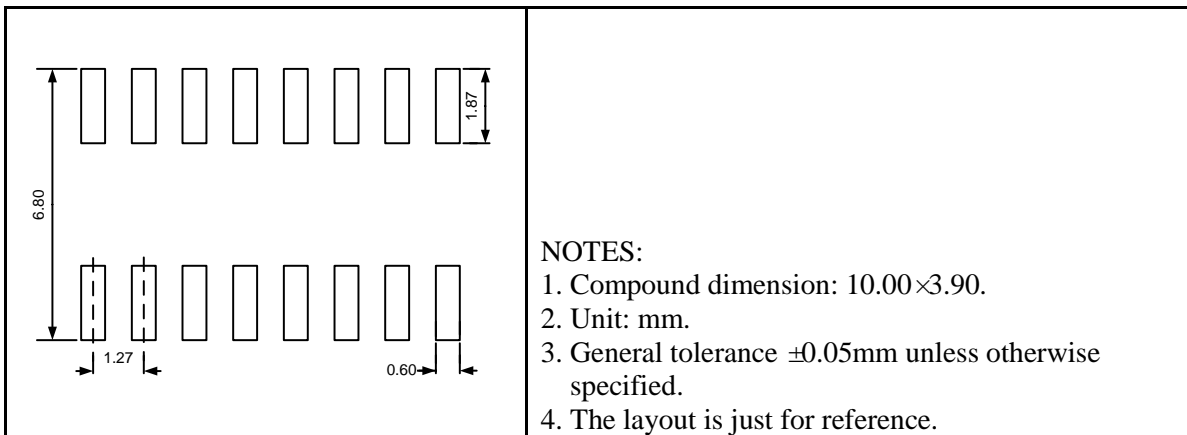

Tape and Reel Orientation

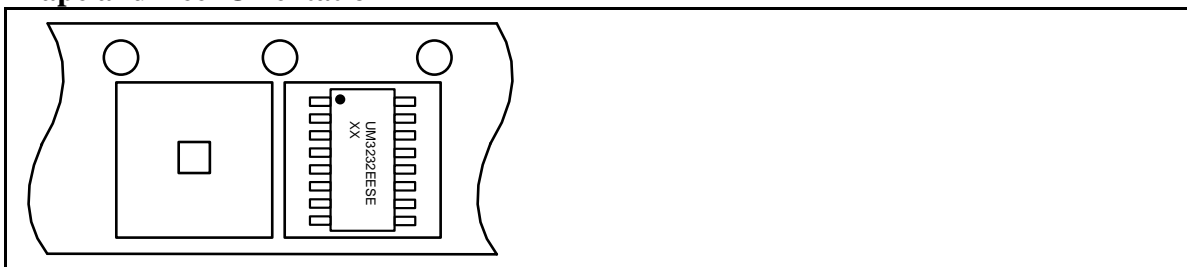

UM3232BEEAE SSOP16

Outline Drawing

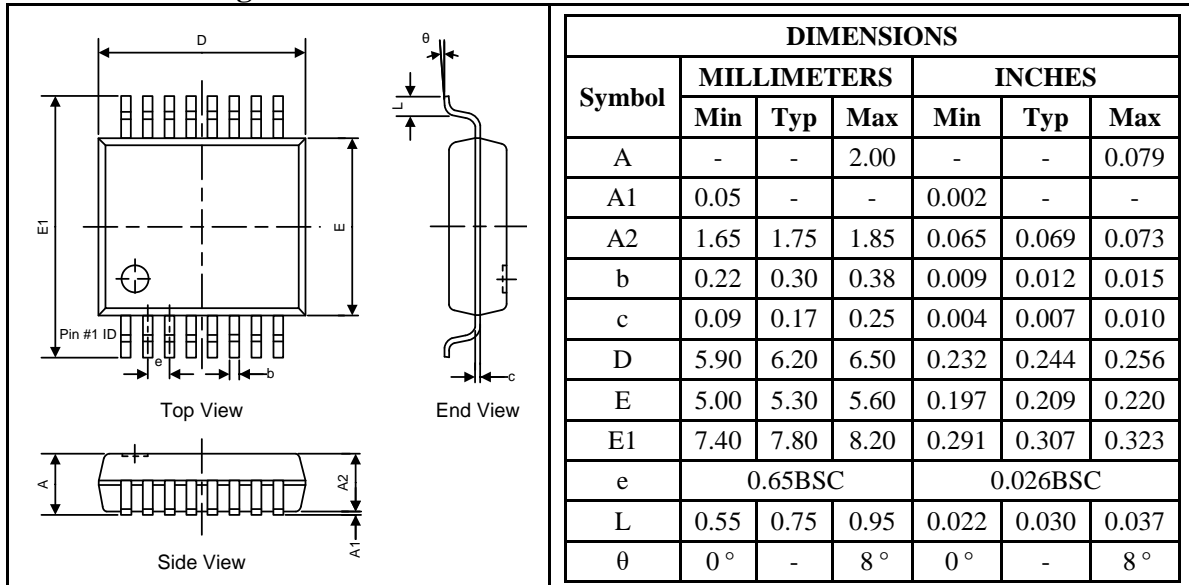

Land Pattern

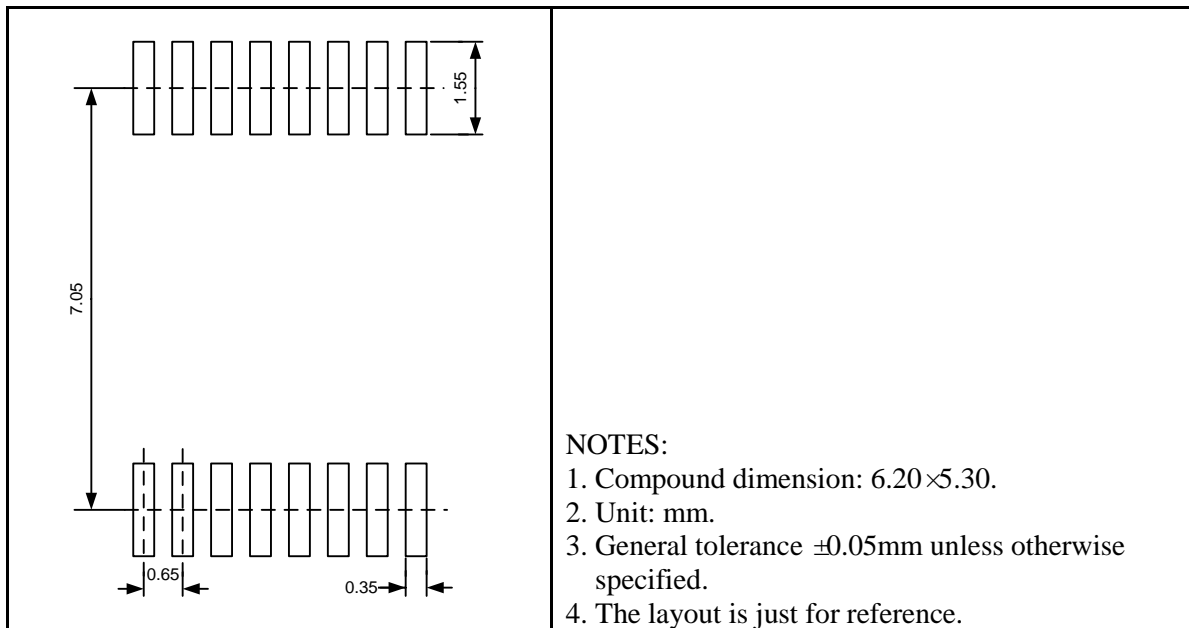

Tape and Reel Orientation

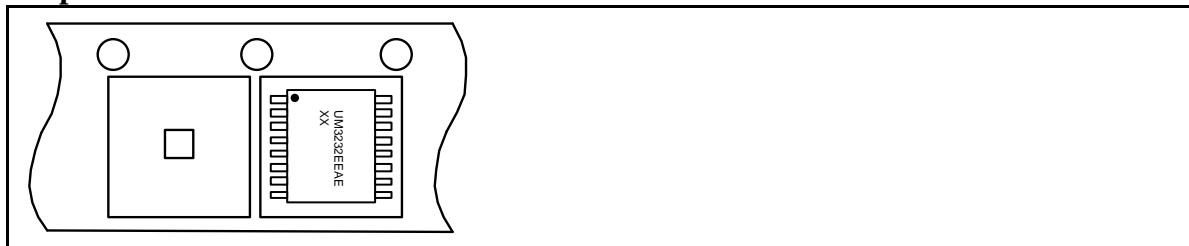

Packing Information

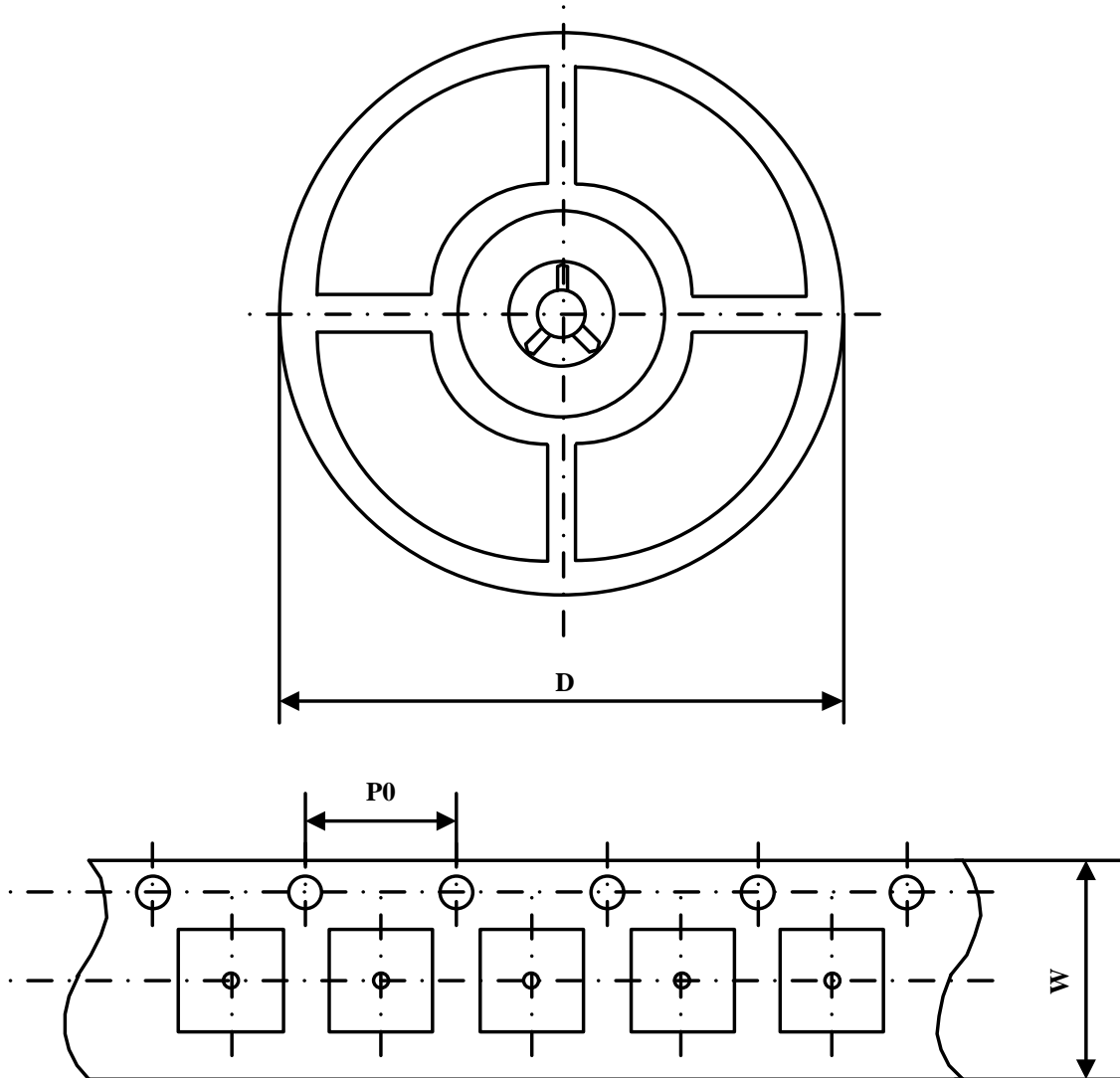

| Part Number | Package Type | Carrier Width(W) | Pitch(P0) | Reel Size(D) |
|-------------|--------------|------------------|-----------|--------------|
| UM3232BEEUE | TSSOP16 | 16 mm | 4 mm | 330 mm |
| UM3232BEESE | SOP16 | 16 mm | 4 mm | 330 mm |
| UM3232BEEAE | SSOP16 | 16 mm | 4 mm | 330 mm |

GREEN COMPLIANCE

Union Semiconductor is committed to environmental excellence in all aspects of its operations including meeting or exceeding regulatory requirements with respect to the use of hazardous substances. Numerous successful programs have been implemented to reduce the use of hazardous substances and/or emissions.

All Union components are compliant with the RoHS directive, which helps to support customers in their compliance with environmental directives. For more green compliance information, please visit:

http://www.union-ic.com/index.aspx?cat_code=RoHSDeclaration

IMPORTANT NOTICE

The information in this document has been carefully reviewed and is believed to be accurate. Nonetheless, this document is subject to change without notice. Union assumes no responsibility for any inaccuracies that may be contained in this document, and makes no commitment to update or to keep current the contained information, or to notify a person or organization of any update. Union reserves the right to make changes, at any time, in order to improve reliability, function or design and to attempt to supply the best product possible.



Union Semiconductor, Inc

Add: Unit 606, No.570 Shengxia Road, Shanghai 201210

Tel: 021-51093966

Fax: 021-51026018

Website: www.union-ic.com