

***±15kV ESD-Protected, Fail-Safe, Hot-Swappable
Auto Polarity Reversal RS-485 Transceivers***

UM3089E SOP14

General Description

The UM3089E series are +5.0V-powered, ±15kV ESD protected, fail-safe, hot-swappable, auto polarity reversal RS-485 transceivers. The device includes fail-safe circuitry, which guarantees a logic-high receiver output when the receiver inputs are open, shorted or idle. This means that the receiver output will be logic high if all transmitters on a terminated bus are disabled (high impedance). The UM3089E features reduced slew-rate driver that minimizes EMI and reduces reflections caused by improperly terminated cables, allowing error-free data transmission up to 500kbps. All transmitter outputs and receiver inputs are protected to ±15kV using the Human Body Model and IEC61000-4-2, Air-Gap Discharge.

The UM3089E includes cable auto-invert functions that reverse the polarity of the RS485 bus pins in case the cable is misconnected. Receiver's full fail-safe features are maintained even when the receiver polarity has been reversed.

The transceivers typically draw 300µA of supply current when unloaded, or when fully loaded with the drivers disabled, and 1µA of supply current when shutdown. The device has a 1/8-unit-load receiver input impedance that allows up to 256 transceivers on the bus and is intended for half-duplex communications. The device also has over current protection and thermal shutdown protection.

Applications

- Air-Condition, Building Lighting and Environmental Control Systems
- Industrial-Control Local Area Networks
- PROFIBUS® and Other RS-485 Based Field Bus Networks
- High Node Count RS-485 Systems
- Transceivers for EMI-Sensitive Applications
- Smart Meters/Automated Meter Reading Systems

Features

- Automatic Polarity Reversal RS-485 Transceivers
- 1µA Shutdown Current and 300µA Receiver Current
- True Fail-Safe Receiver and Hot-Swappable
- Enhanced Slew-Rate Limiting
- Allows up to 256 Transceivers on the Bus
- Thermal Shutdown
- Current-Limiting for Driver Overload Protection.
- ESD Protection for RS-485 I/O Pins
±15kV—IEC61000-4-2, Air-Gap Discharge
±8kV—IEC61000-4-2, Contact Discharge

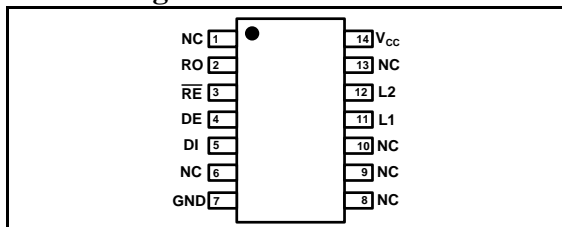
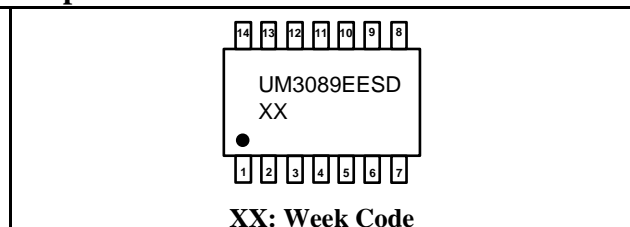
Pin Configurations

Top View

Ordering Information

Part Number	Marking Code	Package Type	Shipping Qty
UM3089EESD	UM3089EESD	SOP14	2500pcs/13 Inch Tape & Reel

Absolute Maximum Ratings

Symbol	Parameter	Value	Unit
V_{CC}	Supply Voltage	+7	V
	Control Input Voltage (\overline{RE} , DE)	-0.3V to ($V_{CC} + 0.3V$)	V
	Driver Input Voltage (DI)	-0.3V to ($V_{CC} + 0.3V$)	V
	Driver Output Voltage (L1, L2)	-7.5 to +12.5	V
	Receiver Input Voltage (L1, L2)	-7.5 to +12.5	V
	Receiver Output Voltage (RO)	-0.3V to ($V_{CC} + 0.3V$)	V
T_A	Ambient Temperature	-40 to +85	°C
T_{STG}	Storage Temperature Range	-65 to +160	°C
T_L	Lead Temperature for Soldering 10 seconds	+300	°C

DC Electrical Characteristics

($V_{CC} = +5V \pm 5\%$, $T_A = T_{MIN}$ to T_{MAX} , unless otherwise noted. Typical values are at $V_{CC} = +5V$ and $T_A = +25$ °C.) (Note 1)

Parameter	Symbol	Test Conditions	Min	Typ	Max	Unit
SUPPLY CURRENT						
Supply Current	I_{CC}	No load, DI = GND or V_{CC}	DE = V_{CC} , $\overline{RE}=0V$ or V_{CC}	0.3		mA
			DE = 0V, $\overline{RE}=0V$	0.25		
Supply Current in Shutdown Mode	I_{SHDN}	DE = GND, $\overline{RE} = V_{CC}$	0.002		10	μA
LOGIC						
Input High Voltage	V_{IH1}	DE, DI, \overline{RE}	2.0			V
Input Low Voltage	V_{IL1}	DE, DI, \overline{RE}			0.4	V
DI Input Hysteresis	V_{HYS}			300		mV
DRIVER						
Differential Driver Output	V_{OD1}	No Load, Figure 2	4.9		5	V
Differential Driver Output	V_{OD2}	Figure 2, $R_L = 54\Omega$	2.0	2.2		V
Change-in-Magnitude of Differential Output Voltage	ΔV_{OD}	Figure 2, $R_L = 54\Omega$; (Note 2)			0.1	V
Driver Common-Mode Output Voltage	V_{OC}	Figure 2, $R_L = 54\Omega$		2.2	2.5	V
Change-in-Magnitude of Common-Mode Voltage	ΔV_{OC}	Figure 2, $R_L = 54\Omega$; (Note 2)			0.1	V
Driver Short-Circuit Output Current (Note 3)	I_{OSD}	$V_{OUT} = -7V$		-250		mA
		$V_{OUT} = 12V$		250		

DC Electrical Characteristics (Continued)

($V_{CC} = +5V \pm 5\%$, $T_A = T_{MIN}$ to T_{MAX} , unless otherwise noted. Typical values are at $V_{CC} = +5V$ and $T_A = +25\text{ }^\circ\text{C}$.) (Note 1)

Parameter	Symbol	Test Conditions	Min	Typ	Max	Unit
RECEIVER						
Receiver Differential Threshold Voltage	V_{TH}	$-7V \leq V_{CM} \leq 12V$	-200		-50	mV
Receiver Input Hysteresis	ΔV_{TH}	$V_{CM} = 0V$		25		mV
Receiver Input Resistance	R_{IN}	$-7V \leq V_{CM} \leq 12V$	96			k Ω
Input Current (L1 and L2)	I_{IN2}	DE = GND, V _{CC} = GND or 5V	$V_{IN} = 12V$	0.1	1.0	mA
			$V_{IN} = -7V$	0.08	-0.8	
Receiver Output High Voltage	V_{OH}	$I_O = -1.5mA$, $V_{ID} = 200mV$	$V_{CC} - 1.5$			V
Receiver Output Low Voltage	V_{OL}	$I_O = 2.5mA$, $V_{ID} = 200mV$			0.4	V
Three-State Output Current at Receiver	I_{OZR}	$0V \leq V_O \leq V_{CC}$			± 1	μA
Receiver Output Short Circuit Current	I_{OSR}	$0V \leq V_{RO} \leq V_{CC}$	± 8		± 60	mA
Thermal Shutdown Temperature	T_{SHDN}			140		$^\circ C$
Thermal Shutdown Hysteresis	ΔT_{SHDN}			20		$^\circ C$
ESD Protection						
ESD Protection for L1, L2		Human Body Model		± 15		kV
		IEC61000-4-2 Air-Gap Discharge		± 15		
		IEC61000-4-2 Contact Discharge		± 8		

Note 1: All currents into the device are positive; all currents out of the device are negative. All voltages are referred to device ground unless otherwise noted.

Note 2: ΔV_{OD} and ΔV_{OC} are the changes in V_{OD} and V_{OC} , respectively, when the DI input changes state.

Note 3: Maximum current level applies to peak current just prior to fold back current limiting; minimum current level applies during current limiting.

Switching Characteristics

($V_{CC} = +5V \pm 5\%$, $T_A = T_{MIN}$ to T_{MAX} , unless otherwise noted. Typical values are at $V_{CC} = +5V$ and $T_A = +25\text{ }^\circ\text{C}$.)

Parameter	Symbol	Test Conditions	Min	Typ	Max	Unit
Maximum Data Rate	f_{MAX}			500		kbps
Driver Input-to-Output	t_{DPLH}	Figures 3 and 7, $R_{DIFF} = 54\Omega$, $C_{L1} = C_{L2} = 100\text{pF}$	50	100	200	ns
	t_{DPHL}		50	100	200	
Driver Output Skew $ t_{DPLH} - t_{DPHL} $	t_{DSKEW}	Figures 3 and 7, $R_{DIFF} = 54\Omega$, $C_{L1} = C_{L2} = 100\text{pF}$		3	100	ns
Driver Rise or Fall Time	t_{DR}, t_{DF}	Figures 3 and 7, $R_{DIFF} = 54\Omega$, $C_{L1} = C_{L2} = 100\text{pF}$	100	200	500	ns
Driver Enable to Output High	t_{DZH}	Figures 4 and 8, $C_L = 100\text{pF}$, S2 closed		100	2500	ns
Driver Enable to Output Low	t_{DZL}	Figures 4 and 8, $C_L = 100\text{pF}$, S1 closed		100	2500	ns
Driver Disable Time from Low	t_{DLZ}	Figures 4 and 8, $C_L = 15\text{pF}$, S1 closed		50	100	ns
Driver Disable Time from High	t_{DHZ}	Figures 4 and 8, $C_L = 15\text{pF}$, S2 closed		50	100	ns
Receiver Input to Output	t_{RPLH} , t_{RPHL}	$ V_{ID} \geq 2.0V$; rise and fall time of $V_{ID} \leq 15\text{ns}$		100	200	ns
Differential Receiver Skew $ t_{RPLH} - t_{RPHL} $	t_{RSKD}	Figures 6 and 9; $ V_{ID} \geq 2.0V$; rise and fall time of $V_{ID} \leq 15\text{ns}$		4	30	ns
Receiver Enable to Output Low	t_{RZL}	Figures 5 and 10, $C_L = 100\text{pF}$, S1 closed		20	200	ns
Receiver Enable to Output High	t_{RZH}	Figures 5 and 10, $C_L = 100\text{pF}$, S2 closed		20	200	ns
Receiver Disable Time from Low	t_{RLZ}	Figures 5 and 10, $C_L = 100\text{pF}$, S1 closed		20	200	ns
Receiver Disable Time from High	t_{RHZ}	Figures 5 and 10, $C_L = 100\text{pF}$, S2 closed		20	200	ns
Time to Shutdown	t_{SHDN}	(Note 4)	50	200	600	ns
Driver Enable from Shutdown to Output High	$t_{DZH(SHDN)}$	Figures 4 and 8, $C_L = 15\text{pF}$, S2 closed			4500	ns
Driver Enable from Shutdown to Output Low	$t_{DZL(SHDN)}$	Figures 4 and 8, $C_L = 15\text{pF}$, S1 closed			4500	ns
Receiver Enable from Shutdown to Output High	$t_{RZH(SHDN)}$	Figures 5 and 10, $C_L = 100\text{pF}$, S2 closed			3500	ns
Receiver Enable from Shutdown to Output Low	$t_{RZL(SHDN)}$	Figures 5 and 10, $C_L = 100\text{pF}$, S1 closed			3500	ns

Note 4: The device is put into shutdown by bringing \overline{RE} high and DE low. If the enable inputs are in this state for less than 50ns, the device is guaranteed not to enter shutdown. If the enable inputs are in this state for at least 600ns, the device is guaranteed to have entered shutdown.

Non-Polarity Features

The Polarities of driver and receiver are always kept the same status. When $DE=\overline{RE}=\text{LOGIC } 0$ and RO is standing LOGIC 0 for T_s time, the polarities will be reversed automatically.

Parameter	Symbol	Test Conditions	Min	Typ	Max	Unit
Waiting Time for Inverting	T_s	$DE=\overline{RE}=L$, RO keeps L	150	200	250	ms

Pin Description

Pin Number	Symbol	Function
1	NC	Not Connected.
2	RO	Receiver Output.
3	\overline{RE}	Receiver Enable. Drive \overline{RE} low to enable receivers, RO is high impedance when \overline{RE} is high. Drive \overline{RE} high and DE low to enter low-power shutdown mode.
4	DE	Driver Enable. Drive DE high to enable drivers. The outputs are high impedance when DE is low. Drive \overline{RE} high and DE low to enter low-power shutdown mode.
5	DI	Driver Input
6	NC	Not Connected.
7	GND	Ground
8	NC	Not Connected.
9	NC	Not Connected.
10	NC	Not Connected.
11	L1	RS485 Receiver Input and Driver Output Pin. Normally L2 is non-inverting bus I/O for transceiver (referred as A in traditional RS485 transceiver) and L1 is inverting bus I/O for transceiver (referred as B in traditional RS485 transceiver). Under polarity reversal status, L2 becomes inverting bus I/O and L1 becomes non-inverting bus I/O.
12	L2	
13	NC	Not Connected.
14	V_{CC}	Power Supply for RS-485 Transceiver

RS-485 Communication Function Table

Table1. Transmitting

INPUTS			OUTPUTS	
\overline{RE}	DE	DI	A	B
X	H	H/O	H	L
X	H	L	L	H
L	L/O	X	Z	Z
H	L/O	X	Shutdown	

Table2. Receiving

INPUTS			OUTPUTS
\overline{RE}	DE	$V_{ID}=V_A-V_B$	RO
L	X	$\geq -50mV$	H
L	X	$\leq -200mV$	L
L	X	Open/Shorted	H
H	H	X	Z
H	L	X	Shutdown

H: High, L: Low, X: Do not care, Z: High impedance.

V_A : Input Voltage of RS485 Non-Inverting Bus I/O terminal,

V_B : Input Voltage of RS485 Inverting Bus I/O terminal.

Typical Operating Characteristics

($V_{CC}=5V$, driver output and receiver output no load, unless otherwise noted.)

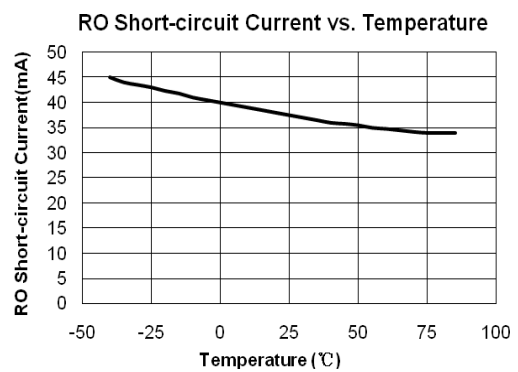
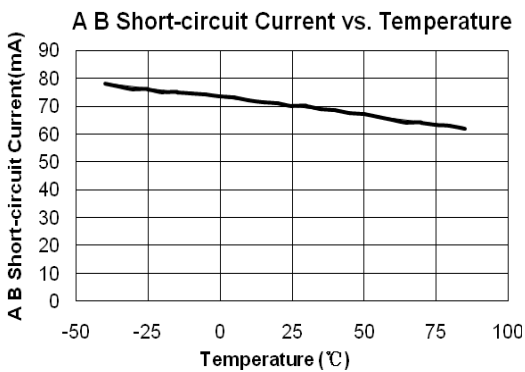
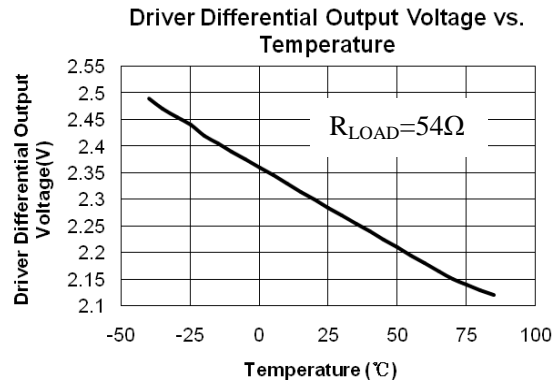
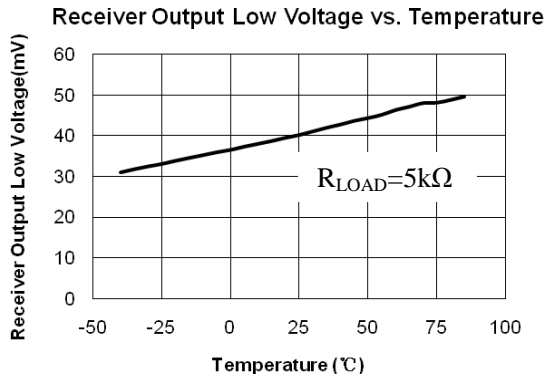
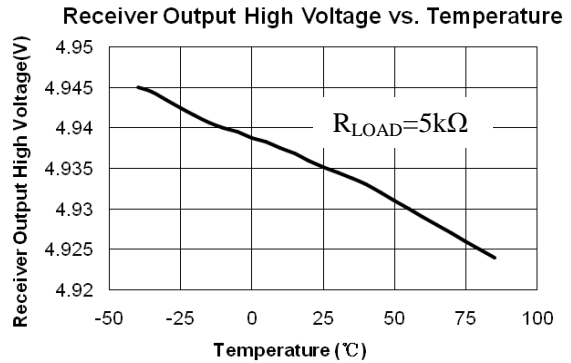
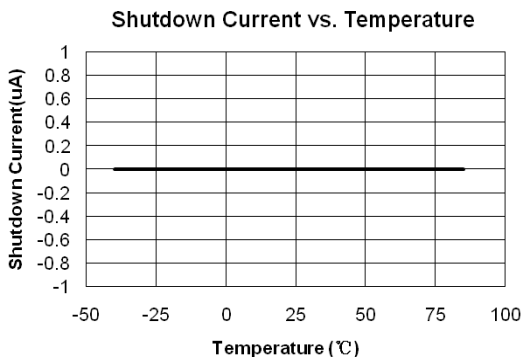
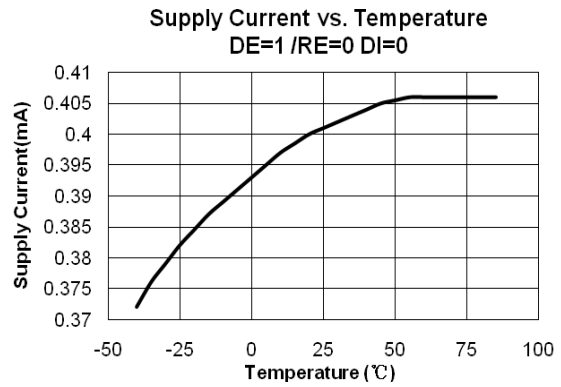
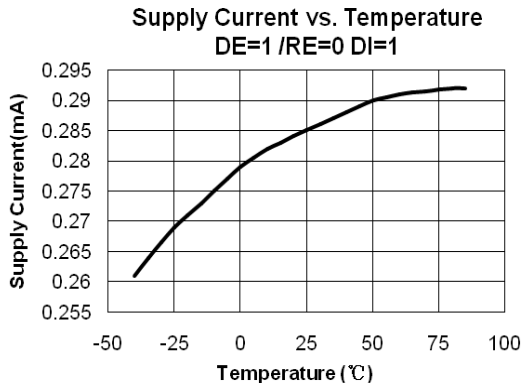

Typical Operating Characteristics (Continued)

($V_{CC}=5V$, driver output and receiver output no load, unless otherwise noted.)

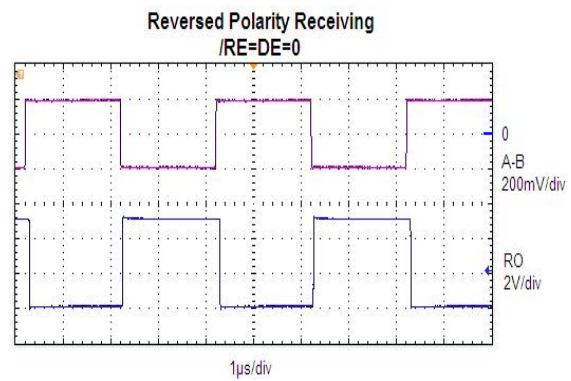
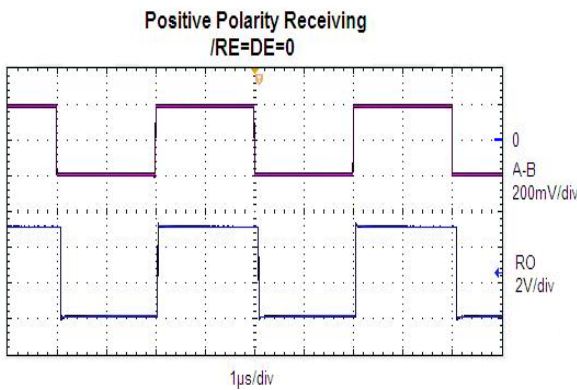
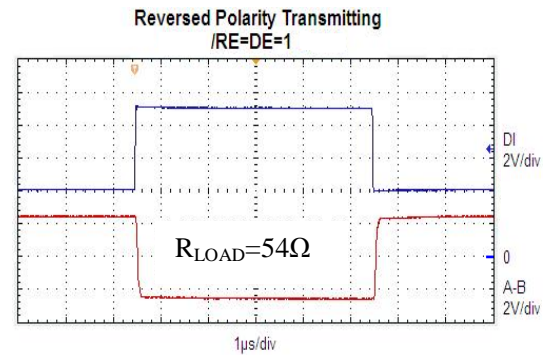
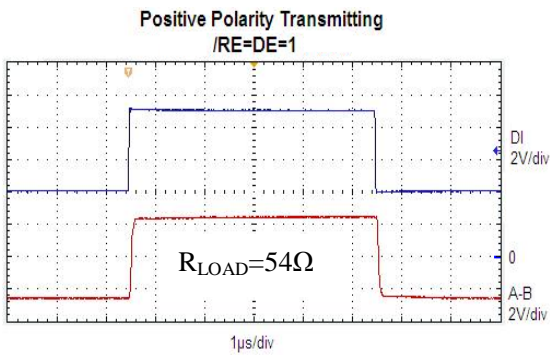
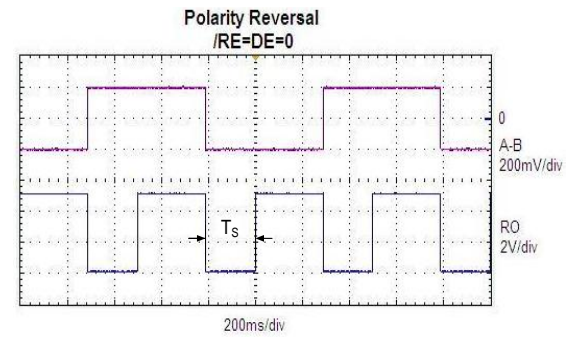
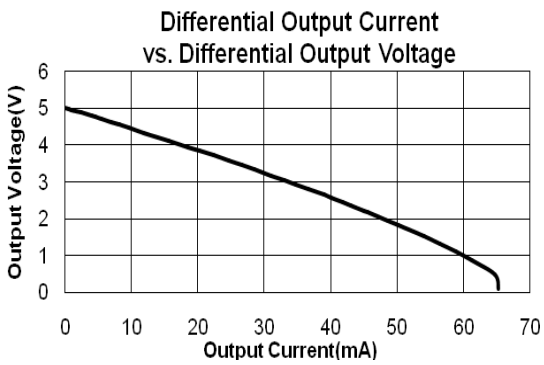
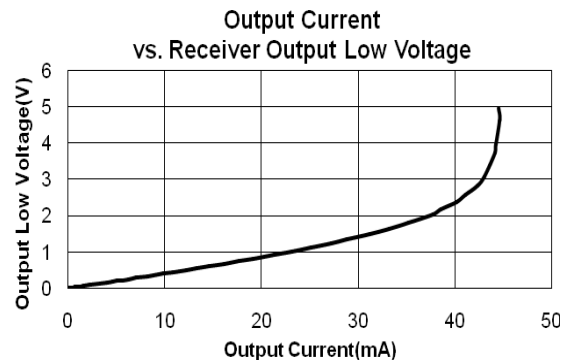
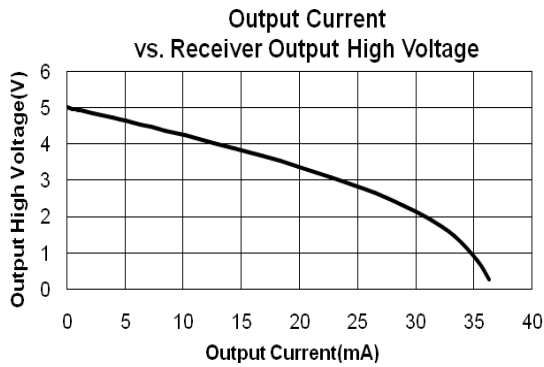

Typical Operating Circuit

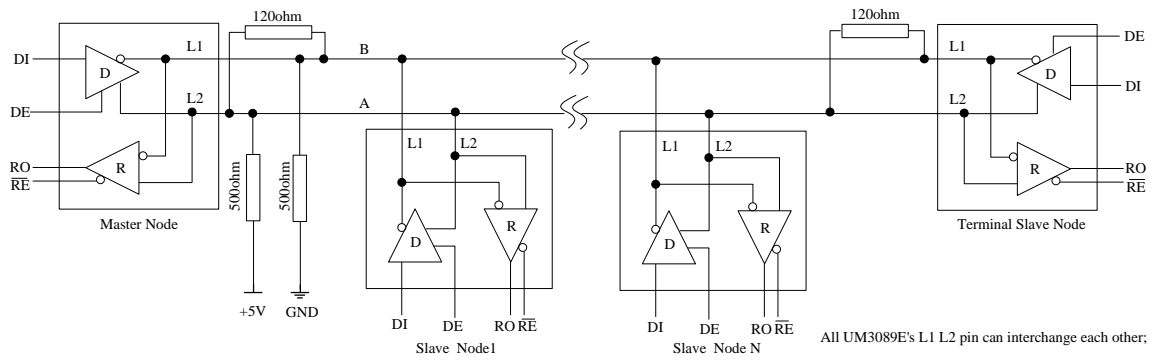

Figure 1. Typical Half-Duplex Non-Polarity RS-485 Network

Test Circuit

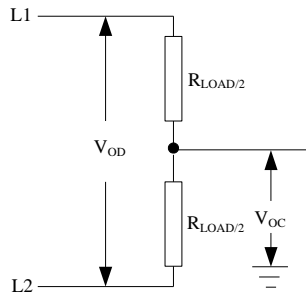

Figure 2. Driver DC Test Load

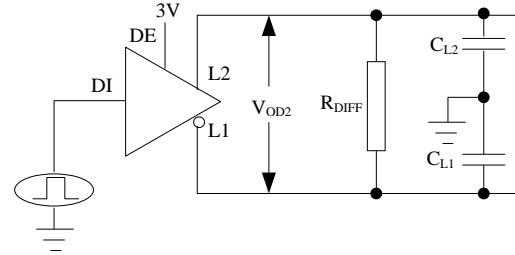

Figure 3. Driver Timing Test Circuit

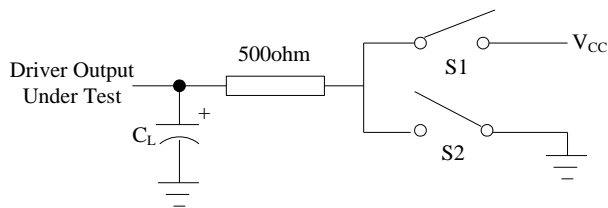

Figure 4. Driver Enable/Disable Timing Test Load

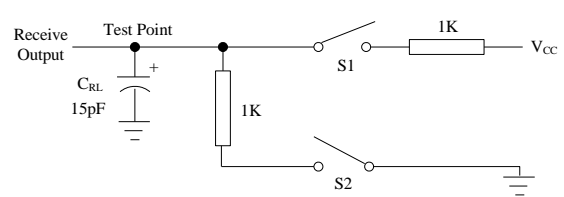

Figure 5. Receiver Enable/Disable Timing Test Load

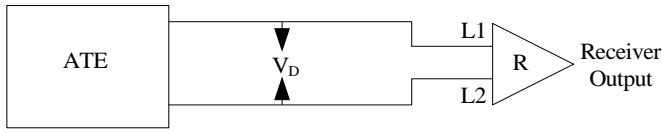

Figure 6. Receiver Propagation Delay Test Circuit

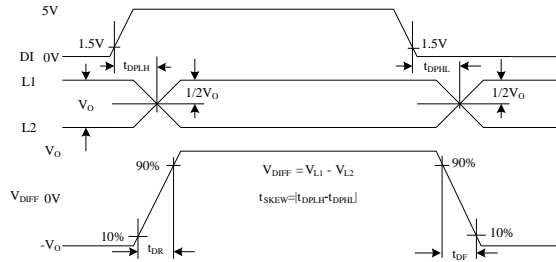

Figure 7. Driver Propagation Delays

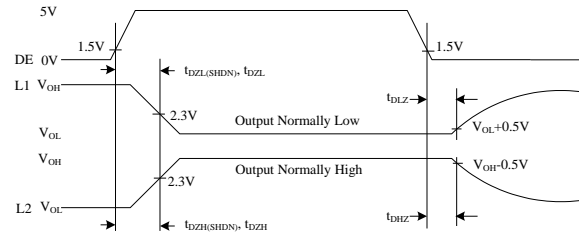

Figure 8. Driver Enable and Disable Times

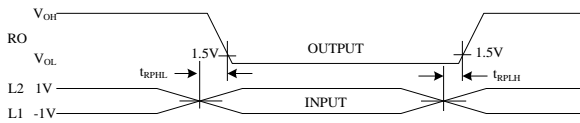

Figure 9. Receiver Propagation Delays

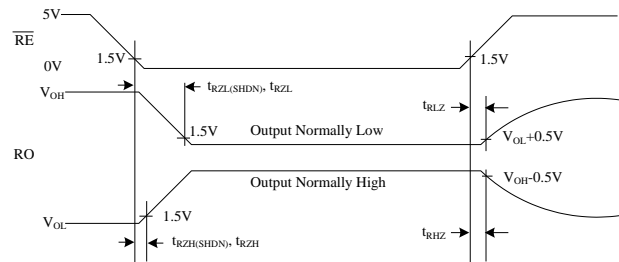

Figure 10. Receiver Enable and Disable Times

Detail Description

Polarity Reversal Function

With large node count RS485 network, it is common for some cable data lines to be wired backwards during installation. When this happens, the node is unable to communicate over network, and must be rewired to the connector, which is time consuming.

The UM3089E simplifies this task by including an automatic polarity reversal function inside.

Upon UM3089E powers up, when $DE=\overline{RE}$ =logic low, if RO keeps logic low over a predefined time T_S (i.e $T_S=200ms$ in UM3089E), the chip reverses its bus pins' polarity, so L1 becomes non-inverting, and L2 becomes inverting. Otherwise, the chip operates like any standard RS485 transceiver, and the bus pins have their normal polarity definition of L2 as non-inverting pin and L1 as inverting pin.

Union Semi's unique automatic polarity reversal function is superior to that found on competing devices, because the receiver's full fail safe function is maintained, even when the RX polarity is reversed.

Fail-Safe and Hot-Swap

The UM3089E guarantees a logic high receiver output when the receiver inputs are shorted or open, or when they are connected to a terminated transmission line with all drivers disabled. This is done by setting the receiver input threshold between -50mV and -200mV. If the differential receiver input voltage V_{ID} is greater than or equal to -50mV, RO is logic high. If V_{ID} is less than or equal to -200mV, RO is logic low. In the case of a terminated bus with all transmitters disabled, the receiver's differential input voltage is pulled to 0V by the termination. With the receiver threshold of UM3089E, this results in logic high with a 50mV minimum noise margin, and this -50mV to -200mV threshold complies with the $\pm 200mV$ EIA/TIA-485 standard.

When circuit boards with RS485 transceiver are inserted into a hot or powered backplane, differential disturbances to the data bus can lead to data errors. Upon initial circuit board insertion, the microprocessor undergoes its own power-up sequence. During this period, the processor's logic output drivers are high impedance and unable to drive the DE and \overline{RE} inputs of these devices to a defined logic level. Leakage currents up to $\pm 10\mu A$ from the high impedance state of processor's logic drivers could cause standard CMOS enable inputs of a transceiver to drift to an incorrect logic level. Additionally, parasitic circuit board capacitance could cause coupling of V_{CC} or GND to the enable inputs. Without the hot-swap capability, these facts could improperly enable the transceiver's driver or receiver.

When V_{CC} rises, an internal pull down circuit holds DE low and \overline{RE} high. After the initial power up sequence, the pull down/pull up circuit becomes transparent, resetting the hot-swap tolerable input. This hot-swap input circuit enhances UM3089E's performance in harsh environment application.

$\pm 15kV$ ESD Protection

All pins on UM3089E device include ESD protection structures, and the family incorporates advanced structures which allow the RS-485 pins (L1, L2) to survive ESD events up to $\pm 15kV$. The RS-485 pins are particularly vulnerable to ESD damage because they typically connect to an exposed port on the exterior of the finished product. The ESD structures withstand high ESD in all states: normal operation, shutdown, and powered down. After an ESD event, circuits keep working without latch up. The ESD protection can be tested in various ways and with reference to the ground pin. The L1, L2 are characterized for protection to the following limits: $\pm 15kV$ using the Human Body Model and IEC61000-4-2, Air-Gap Discharge, and $\pm 8kV$ Contact Discharge.

The logic pins (RO, \overline{RE} , DE, DI) are characterized for protection to the following limits: $\pm 2kV$ using the Human Body Model.

Applications Information

Non-Polarity transceiver

When established the non-polarity RS-485 net, you should pay attention to two conditions. First, a pair of bias resistance (pull-up to +5V for RS-485 A bus, push-down to GND for RS-485 B bus) must be required, usually be built in the master node, or independently, 500Ω resistance is recommended. The other nodes don't need bias resistance anymore. Second, the transceiver rate must be higher than 100bps or the maximum transmitting time for low logic should be less than 100ms.

256 Transceivers on the Bus

The standard RS-485 receiver input impedance is 12kΩ (one unit load), and the standard driver can drive up to 32 unit loads. The Union family of transceivers have a 1/8 unit load receiver input impedance (96kΩ), allowing up to 256 transceivers to be connected in parallel on one communication line. Any combination of these devices and/or other RS-485 transceivers with a total of 32 unit loads or less can be connected to the line.

Low-Power Shutdown Mode

Low-power shutdown mode is initiated by bringing both \overline{RE} high and DE low. In shutdown, the device typically draws only 10uA of supply current. \overline{RE} and DE may be driven simultaneously; the parts are guaranteed not to enter shutdown if \overline{RE} is high and DE is low for less than 50ns. If the inputs are in this state for at least 600ns, the parts are guaranteed to enter shutdown. Enable times t_{ZH} and t_{ZL} in the Switching Characteristics tables assume the part was not in a low-power shutdown state. Enable times $t_{ZH(SHDN)}$ and $t_{ZL(SHDN)}$ assume the parts were shut down. It takes drivers and receivers longer to become enabled from low-power shutdown mode ($t_{ZH(SHDN)}$, $t_{ZL(SHDN)}$) than from driver/receiver-disable mode (t_{ZH} , t_{ZL}).

Driver Output Protection

Two mechanisms prevent excessive output current and power dissipation caused by faults or by bus contention. The first, a foldback current limit on the output stage, provides immediate protection against short circuits over the whole common-mode voltage range (see Typical Operating Characteristics). The second, a thermal shutdown circuit, forces the driver outputs into a high-impedance state if the die temperature becomes excessive.

Line Length vs. Data Rate

The RS-485/RS-422 standard covers line lengths up to 4000 feet. For line lengths greater than 4000 feet, repeater is required.

Typical Applications

The UM3089E transceivers are designed for bidirectional data communications on multipoint bus transmission lines. To minimize reflections, the line should be terminated at both ends in its characteristic impedance, and stub lengths of the main line should be kept as short as possible.

Package Information

UM3089EESD SOP14

Outline Drawing

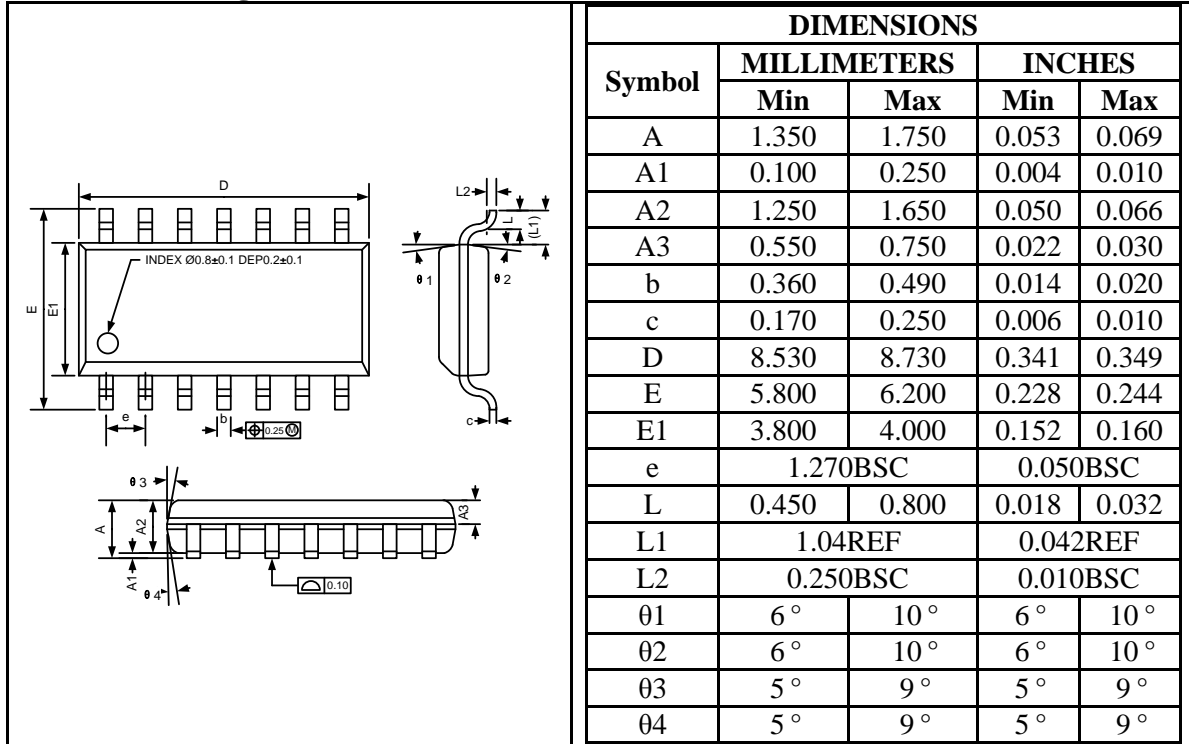

Land Pattern

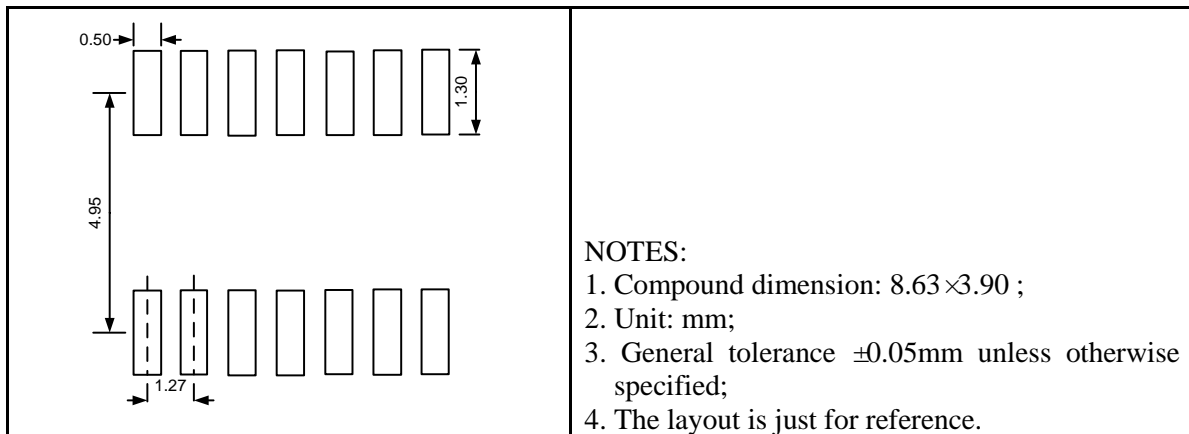

Tape and Reel Orientation

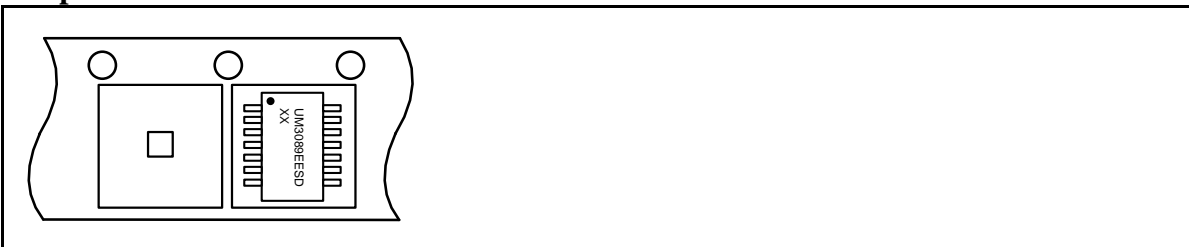

IMPORTANT NOTICE

The information in this document has been carefully reviewed and is believed to be accurate. Nonetheless, this document is subject to change without notice. Union assumes no responsibility for any inaccuracies that may be contained in this document, and makes no commitment to update or to keep current the contained information, or to notify a person or organization of any update. Union reserves the right to make changes, at any time, in order to improve reliability, function or design and to attempt to supply the best product possible.



Union Semiconductor, Inc

Add: Unit 606, No.570 Shengxia Road, Shanghai 201210

Tel: 021-51093966

Fax: 021-51026018

Website: www.union-ic.com