

0.4Ω Ultra Low ON-Resistance, Dual, SPDT Analog Switch

UM2268 QFN10 1.8×1.4

General Description

The UM2268 is a dual, low-power single-pole/double-throw (SPDT) analog switch that operates from a single +1.8V to +4.4V supply.

The UM2268 features guaranteed on-resistance matching (0.04Ω TYP) between switches and guaranteed on resistance flatness over the signal range (0.08Ω TYP), as well as high off-isolation and low crosstalk. This ensures excellent linearity and low distortion when switching audio signals. The UM2268 is available in Pb-free QFN10 package (1.8mm×1.4mm×0.55mm).

Applications

- Portable Instrumentation
- Battery-Operated Equipment
- Computer Peripherals
- Speaker and Earphone Switching
- Medical Equipment
- Audio and Video Switching

Features

- V_{CC} Operating Range: +1.8V to +4.4V
- Low On-Resistance: 0.4Ω (TYP) @ +4.4V
- On-Resistance Matching: 0.04Ω (TYP)
- On-Resistance Flatness: 0.08Ω (TYP)
- -3dB Bandwidth: 80MHz
- Low Off-Isolation: -78dB (100kHz)
- Low Crosstalk: -93dB (100kHz)
- TTL/CMOS Compatible
- Break-Before-Make Switching
- Rail-to-Rail Input and Output Operation
- Lead (Pb)-Free QFN10 Package

Pin Configurations

Top View

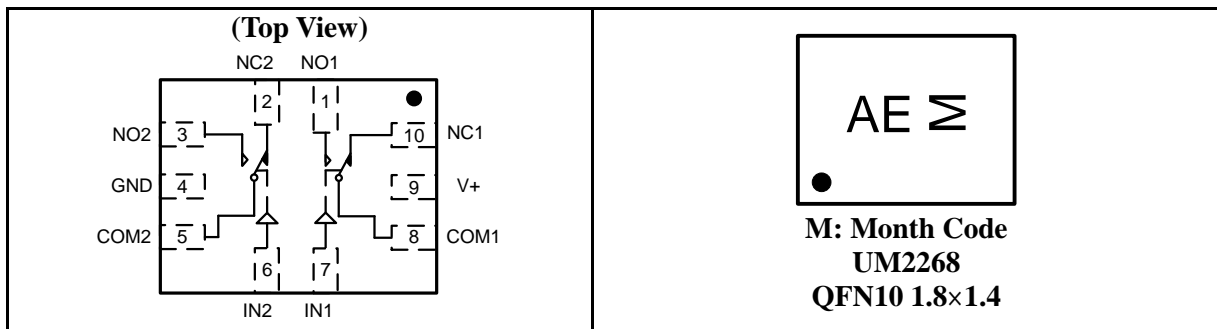

Ordering Information

Part Number	Packaging Type	Marking Code	Shipping Qty
UM2268	QFN10 1.8×1.4	AE	3000pcs/7 Inch Tape & Reel

Pin Description

Pin Number	Pin Name	Function
1, 3	NO1, NO2	Normally-Open Terminal
10, 2	NC1, NC2	Normally-Closed Terminal
4	GND	Ground
8, 5	COM1, COM2	Common Terminal
7, 6	IN1, IN2	Digital Control Pin to Connect the COM Terminal to the NO or NC Terminals
9	V+	Power Supply

Function Table

LOGIC	NO	NC
0	OFF	ON
1	ON	OFF

Absolute Maximum Ratings

Symbol	Parameter	Limit	Unit
V ₊	Supply Voltage	0 to +4.6	V
V _{IS}	Analog Switch Input Voltage	-0.3 to (V _{CC} +0.3)	
V _{IN}	Digital Select Input Voltage	0 to +4.6	
I _D	Continuous DC Current	250	mA
I _P	Peak Current	350	mA
T _O	Operating Temperature Range	-40 to +85	°C
T _{STG}	Storage Temperature Range	-65 to +150	
ESD	HBM	4000	V

Electrical Characteristics

$V_+ = +4.4V$, $GND = 0V$, $T_A = -40^\circ C$ to $+85^\circ C$, unless otherwise noted.

Symbol	Parameter	Test Conditions	Vcc (V)	Temp	Limits (-40°C to 85°C)			Unit
					Min	Typ (Note 1)	Max	
V_+	Power Supply Range			Full	1.8		4.4	V
I_{CC}	Quiescent Supply Current	$V_{IN} = V_+$ or 0	4.4	Full			1.0	μA
I_{IN}	Input Leakage Current	$V_{IN} = 0V/4.4V$	4.4	Full			1.0	μA
I_{OFF}	Power Off Leakage Current	$V_{NO}/V_{NC} = 3.3V/0.3V$, $V_{COM} = 0.3V/3.3V$	4.4	Full			1.0	μA
I_{ON}	Channel ON Leakage Current	$V_{COM} = 0.3V/3.3V$ V_{NO} or $V_{NC} = 0.3V/3.3V$, or Floating	4.4	Full			1.0	μA
R_{ON}	On-Resistance (Note 2)	V_{NO}, V_{NC} or $V_{COM} = 1.0V$, $I_{COM} = -100mA$	4.4	Room Full		0.4	0.75 0.85	Ω
ΔR_{ON}	On Resistance Match Between Channels (Note 2, 3, 4)	V_{NO}, V_{NC} or $V_{COM} = 1.0V$, $I_{COM} = -100mA$	4.4	Room Full		0.04	0.15 0.20	Ω
R_{FLAT}	On Resistance Flatness (Note 2, 3, 5)	V_{NO}, V_{NC} or $V_{COM} = 1.0V, 2.5V$ $I_{COM} = -100mA$	4.4	Room Full		0.08	0.12 0.20	Ω
V_{IH}	Input High Voltage		4.4	Full	2.0			V
V_{IL}	Input Low Voltage		4.4	Full			0.5	V
t_{ON}	Turn On Time	$V_{IN} = 2.1V$ to $0V$, $R_L = 50\Omega$, $C_L = 35pF$, V_{NO1} or $V_{NC1} = V_{NO2}$ or $V_{NC2} = 2.1V$, Test Circuit 1	4.4	Room		88		ns
t_{OFF}	Turn Off Time	$V_{IN} = 2.1V$ to $0V$, $R_L = 50\Omega$, $C_L = 35pF$, V_{NO1} or $V_{NC1} = V_{NO2}$ or $V_{NC2} = 2.1V$, Test Circuit 1	4.4	Room		16		ns
t_{BBM}	Break Before Make Time (Note 6)	$V_{IN} = 2.1V$ to $0V$, $R_L = 50\Omega$, $C_L = 35pF$, V_{NO1} or $V_{NC1} = V_{NO2}$ or $V_{NC2} = 2.1V$, Test Circuit 2	4.4	Room		6		ns
O_{IRR}	Off Isolation (Note 7)	$V_{BIAS} = 2.1V$, Signal=0dBm, Test Circuit 3	4.4	Room		-78		dB
				Room		-58		dB
X_{TALK}	Crosstalk	$V_{BIAS} = 2.1V$, Signal=0dBm, Test Circuit 4	4.4	Room		-93		dB
				Room		-90		dB
BW	-3dB Bandwidth	$V_{BIAS} = 2.1V$, Signal=0dBm, Test Circuit 5	4.4	Room		80		MHz
Q	Charge Injection Select Input to Common I/O	$V_G = 0V$, $R_S = 0\Omega$, $C_L = 1.0nF$, Test Circuit 6	4.4	Room		4.0		pC
C_{ON}	HSD+ HSD- ON Capacitance (Note 8)		4.4	Room		56		pF

Note 1: Typically values are at $V_+ = 4.4V$ and $T_A = +25^\circ C$.

Note 2: Guaranteed by design. Resistance measurements do not include test circuit or package resistance.

Note 3: Parameter is characterized but not tested in production.

Note 4: $\Delta R_{ON} = |R_{ON(NO1/NC1)} - R_{ON(NO2/NC2)}|$ measured at identical V_{CC} , temperature and voltage levels.

Note 5: Flatness is defined as the difference between the maximum and minimum value of On Resistance over the specified range of conditions.

Note 6: Guaranteed by design.

Note 7: Off Isolation = $20 \log_{10} [V_{COM}/V_{NO/NC}]$.

Note 8: $T_A = +25^\circ C$, $f = 1MHz$, Capacitance is characterized but not tested in production.

Electrical Characteristics

$V_{+}=+2.7V$ to $+3.6V$, $T_A=-40^{\circ}C$ to $+85^{\circ}C$, unless otherwise noted.

Symbol	Parameter	Test Conditions	Vcc (V)	Temp	Limits (-40°C to 85°C)			Unit
					Min	Typ (Note 1)	Max	
V_{NO}, V_{NC}, V_{COM}	Analog Signal Range			Full	0		V+	V
I_{IN}	Input Leakage Current	$V_{IN}=0V/2.7V$	2.7	Full			1.0	μA
I_{OFF}	Power Off Leakage Current	$V_{NO}/V_{NC}=3.3V/0.3V,$ $V_{COM}=0.3V/3.3V$	3.6	Full			1.0	μA
I_{ON}	Channel ON Leakage Current	$V_{COM}=0.3V/3.3V$ V_{NO} or $V_{NC}=0.3V/3.3V$, or Floating	3.6	Full			1.0	μA
R_{ON}	On-Resistance (Note 2)	V_{NO}, V_{NC} or $V_{COM}=1.0V,$ $I_{COM}=-100mA$	2.7	Room Full		0.75	1.10 1.20	Ω
ΔR_{ON}	On Resistance Match Between Channels (Note 2, 3, 4)	V_{NO}, V_{NC} or $V_{COM}=1.0V,$ $I_{COM}=-100mA$	2.7	Room Full		0.03	0.15 0.20	Ω
R_{FLAT}	On Resistance Flatness (Note 2, 3, 5)	V_{NO}, V_{NC} or $V_{COM}=1.0V, 2.5V$ $I_{COM}=-100mA$	2.7	Room Full		0.10	0.18 0.20	Ω
V_{IH}	Input High Voltage		3.0	Full	1.5			V
V_{IL}	Input Low Voltage		3.0	Full			0.4	V
t_{ON}	Turn On Time	$V_{IN}=1.5V$ to $0V,$ $R_L=50\Omega, C_L=35pF,$ V_{NO1} or $V_{NC1}=V_{NO2}$ or $V_{NC2}=1.5V$, Test Circuit 1	3.0	Room		100		ns
t_{OFF}	Turn Off Time	$V_{IN}=1.5V$ to $0V,$ $R_L=50\Omega, C_L=35pF,$ V_{NO1} or $V_{NC1}=V_{NO2}$ or $V_{NC2}=1.5V$, Test Circuit 1	3.0	Room		20		ns
t_{BBM}	Break Before Make Time (Note 6)	$V_{IN}=1.5V$ to $0V,$ $R_L=50\Omega, C_L=35pF,$ V_{NO1} or $V_{NC1}=V_{NO2}$ or $V_{NC2}=1.5V$, Test Circuit 2	3.0	Room		9.2		ns
O_{IRR}	Off Isolation (Note 7)	$V_{BIAS}=2.1V,$ Signal=0dBm, Test Circuit 3	3.0	Room		-78		dB
				Room		-58		dB
X_{TALK}	Crosstalk	$V_{BIAS}=2.1V,$ Signal=0dBm, Test Circuit 4	3.0	Room		-93		dB
				Room		-90		dB
BW	-3dB Bandwidth	$V_{BIAS}=2.1V,$ Signal=0dBm, Test Circuit 5	3.0	Room		80		MHz
Q	Charge Injection Select Input to Common I/O	$V_G=0V, R_S=0\Omega,$ $C_L=1.0nF$, Test Circuit 6	3.0	Room		3.0		pC
C_{ON}	HSD+ HSD- ON Capacitance (Note 8)		3.0	Room		56		pF

Note 1: $T_A=+25^{\circ}C$.

Note 2: Guaranteed by design. Resistance measurements do not include test circuit or package resistance.

Note 3: Parameter is characterized but not tested in production.

Note 4: $\Delta R_{ON} = |R_{ON(NO1/NC1)} - R_{ON(NO2/NC2)}|$ measured at identical V_{CC} , temperature and voltage levels.

Note 5: Flatness is defined as the difference between the maximum and minimum value of On Resistance over the specified range of conditions.

Note 6: Guaranteed by design.

Note 7: Off Isolation= $20 \log_{10} [V_{COM}/V_{NO/NC}]$.

Note 8: $T_A=+25^{\circ}C$, $f=1MHz$, Capacitance is characterized but not tested in production.

Typical Operating Characteristics

($T_A=+25^\circ\text{C}$, unless otherwise noted.)

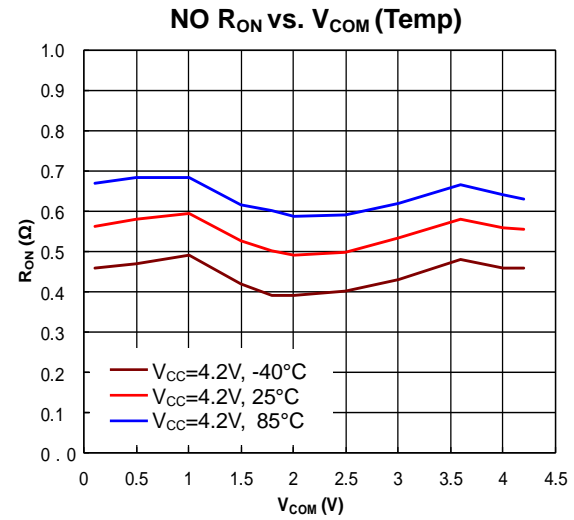
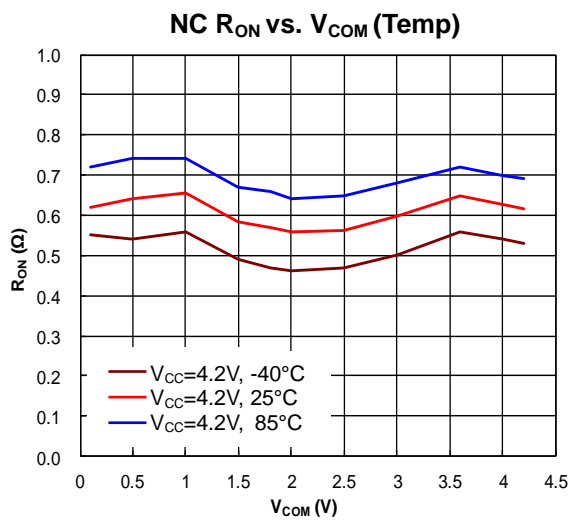
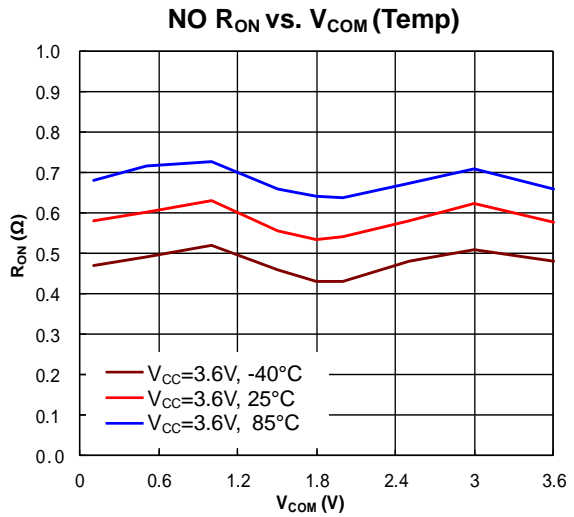
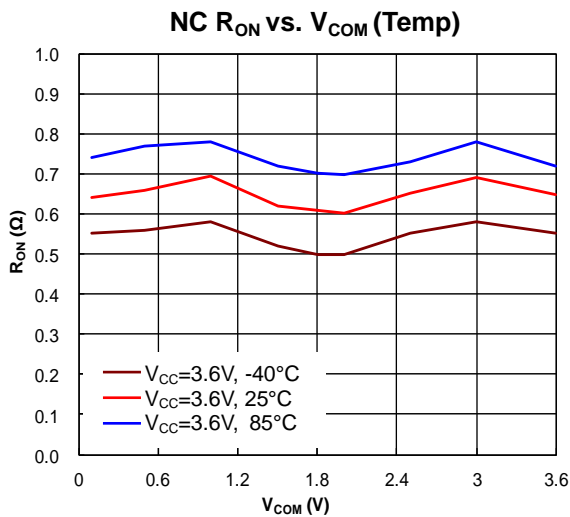
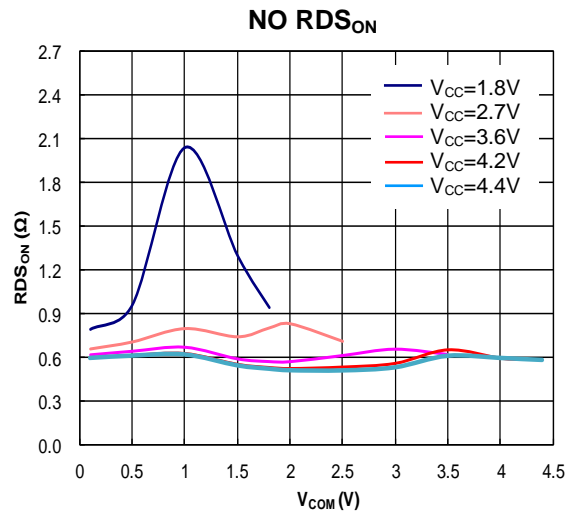
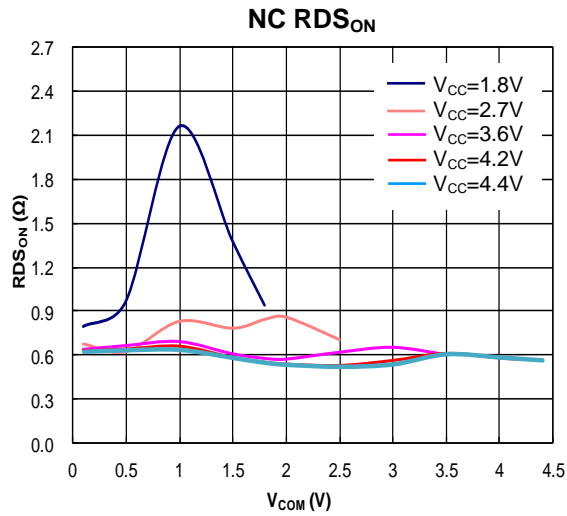

Typical Operating Characteristics (Continued)

($T_A=+25^\circ\text{C}$, unless otherwise noted.)

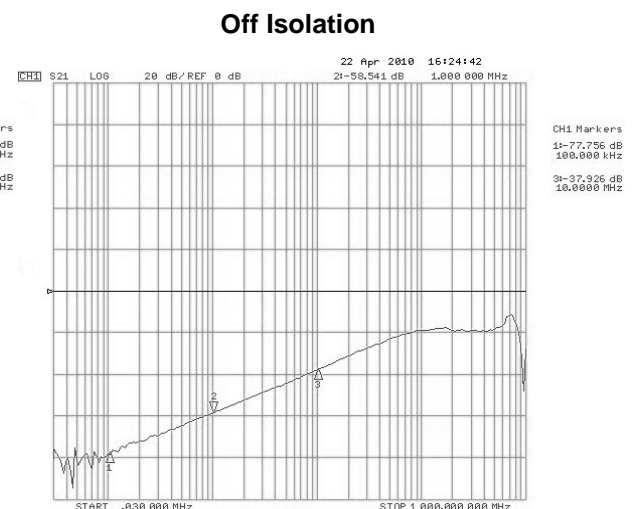
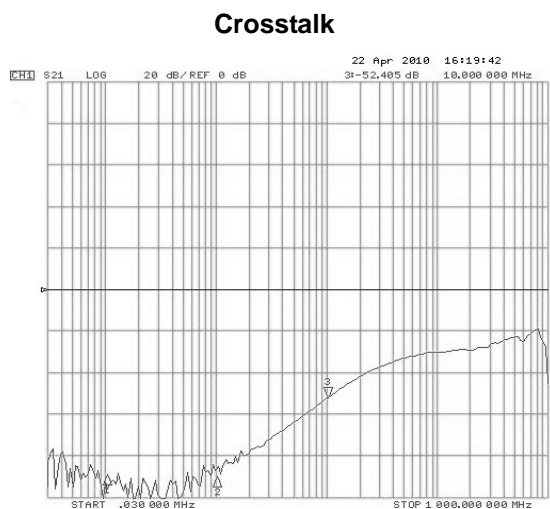
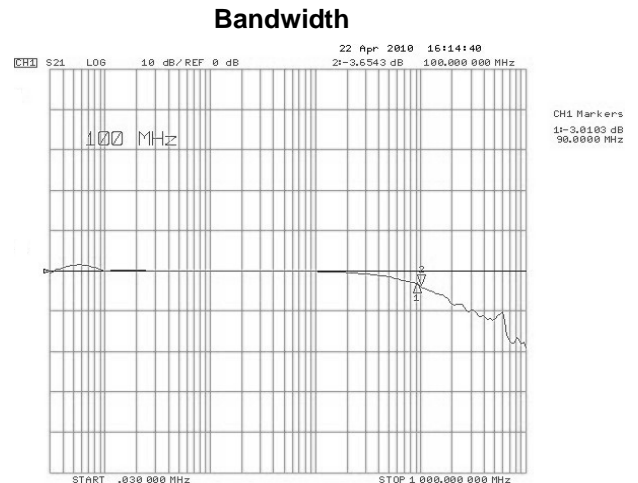
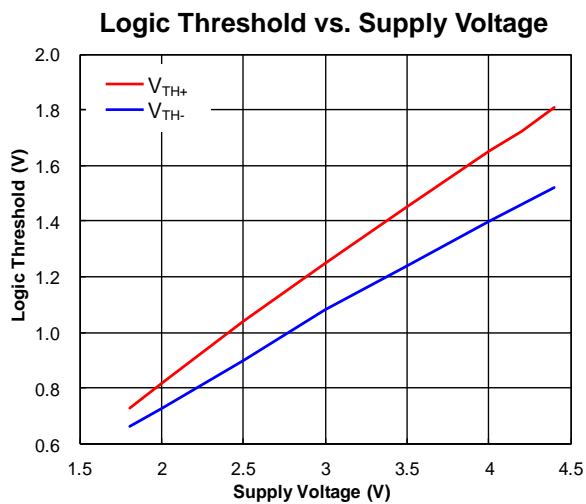
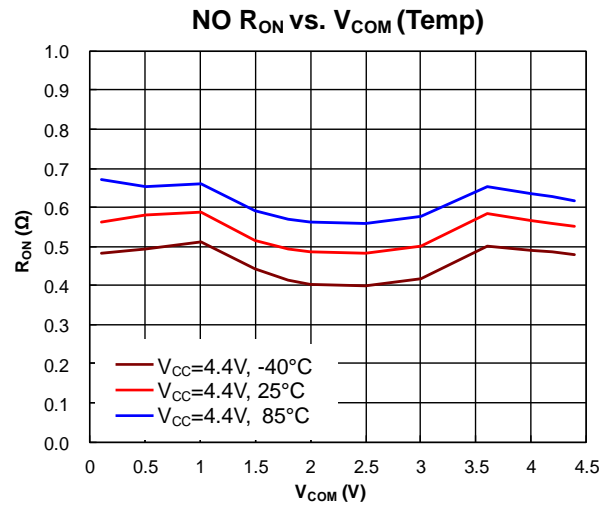
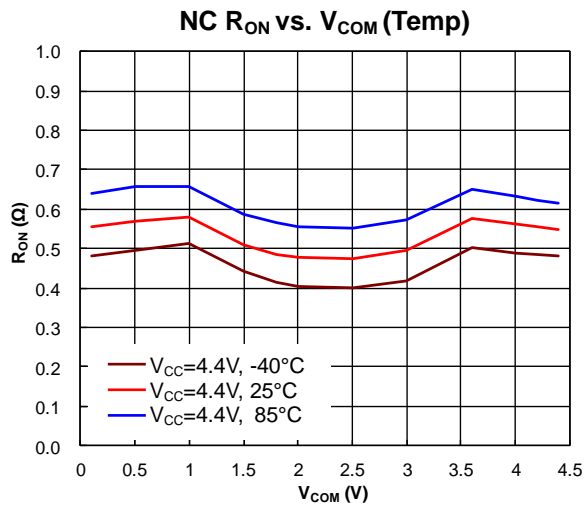

Test Circuits

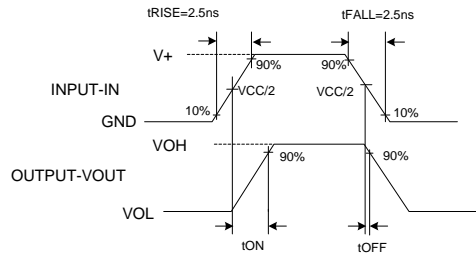
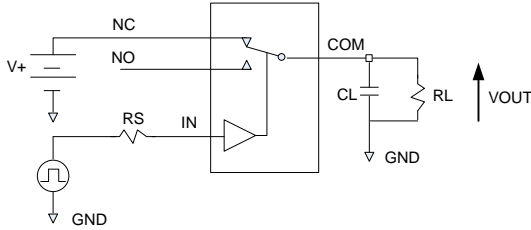

Test Circuit 1. Switching Timing (t_{ON} , t_{OFF})

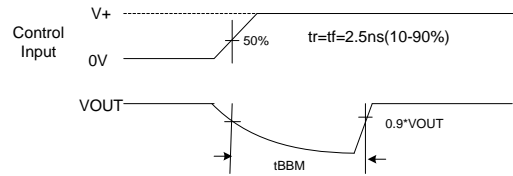
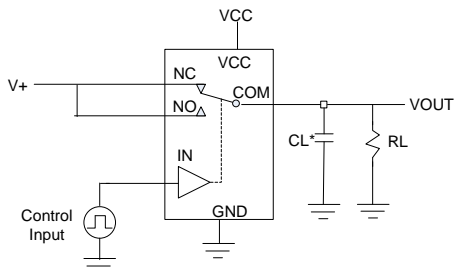

CL* includes fixture and stray capacitance

Test Circuit 2. Break-Before-Make Timing

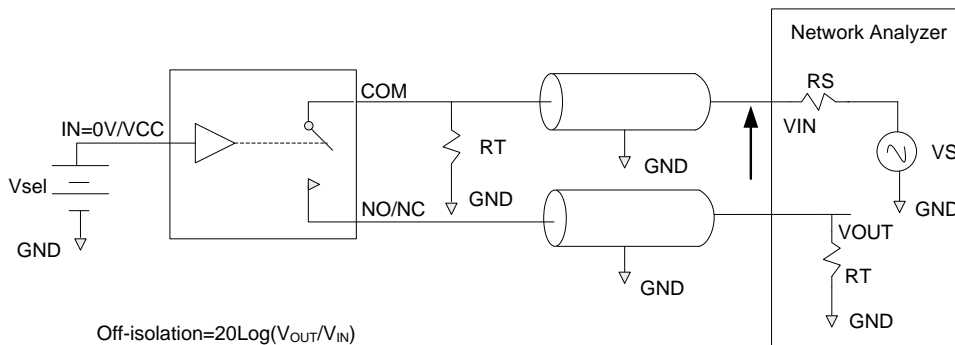

Test Circuit 3. Off-Isolation

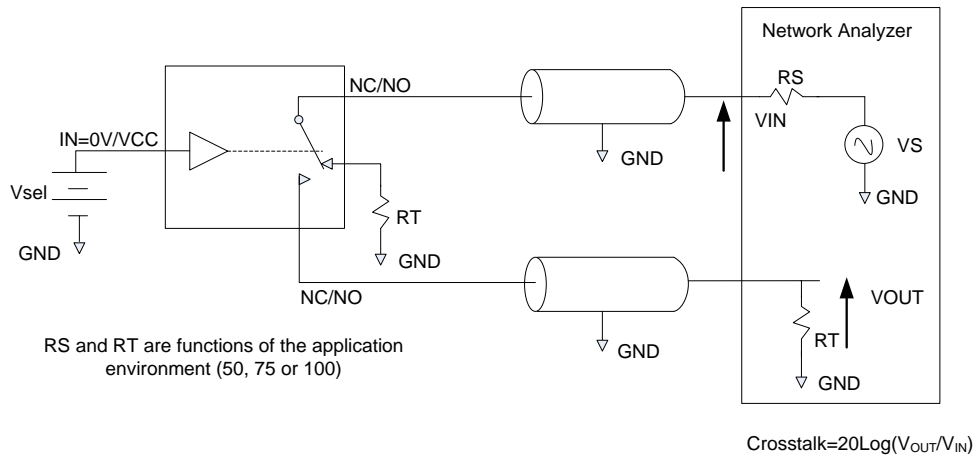

Test Circuit 4. Channel-to-Channel Crosstalk

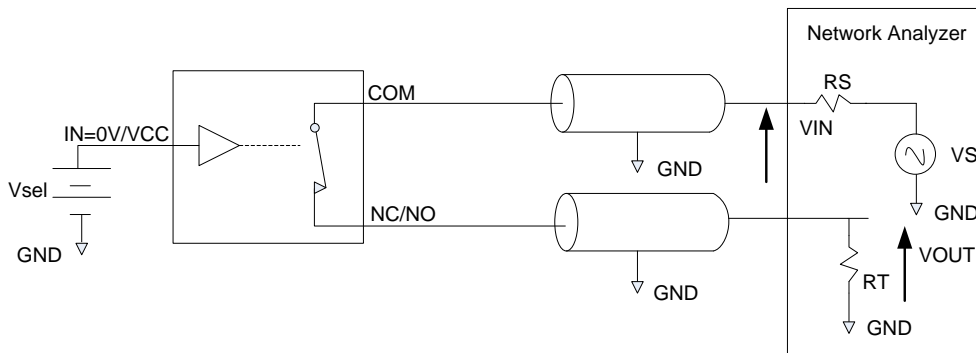

Test Circuit 5. Bandwidth

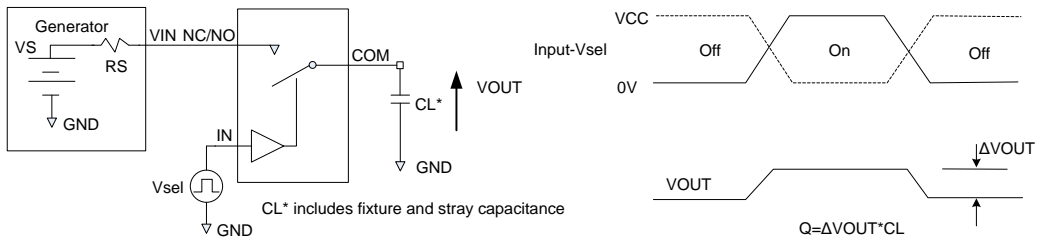

Test Circuit 6. Charge Injection Test

Package Information

UM2268 QFN10 1.8×1.4

Outline Drawing

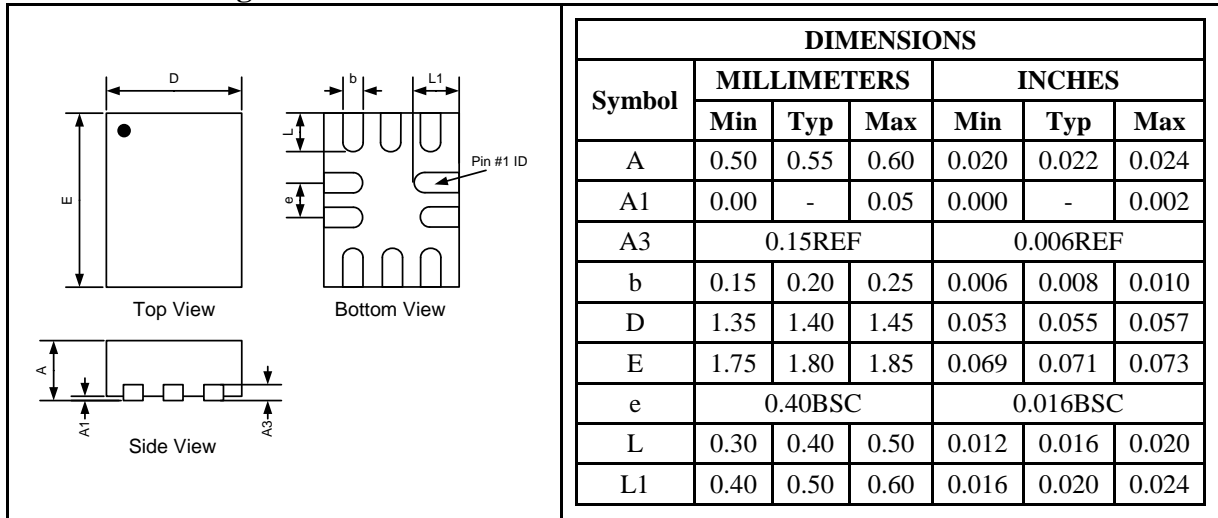

Land Pattern

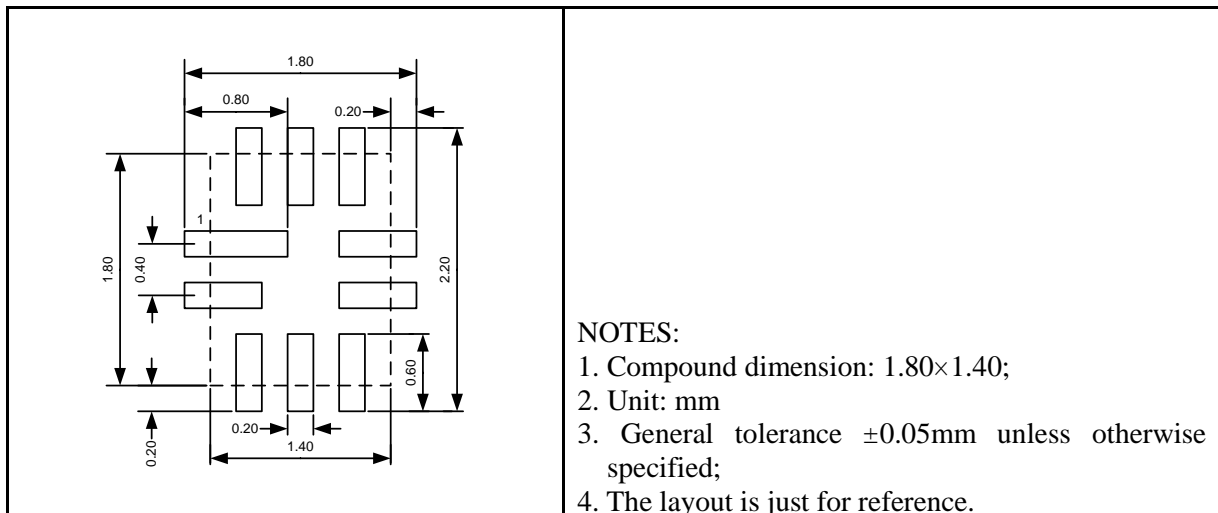

Tape and Reel Orientation

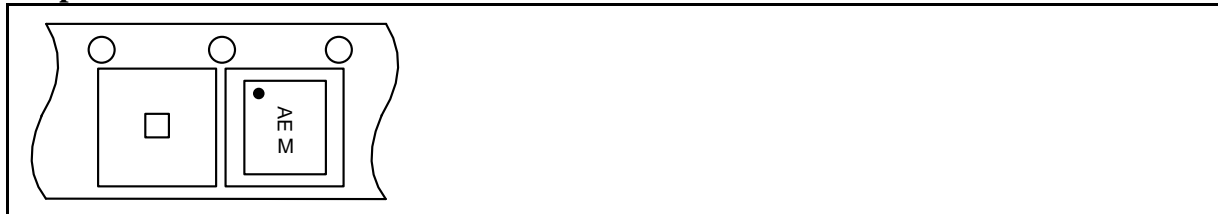

GREEN COMPLIANCE

Union Semiconductor is committed to environmental excellence in all aspects of its operations including meeting or exceeding regulatory requirements with respect to the use of hazardous substances. Numerous successful programs have been implemented to reduce the use of hazardous substances and/or emissions.

All Union components are compliant with the RoHS directive, which helps to support customers in their compliance with environmental directives. For more green compliance information, please visit:

http://www.union-ic.com/index.aspx?cat_code=RoHSDeclaration

IMPORTANT NOTICE

The information in this document has been carefully reviewed and is believed to be accurate. Nonetheless, this document is subject to change without notice. Union assumes no responsibility for any inaccuracies that may be contained in this document, and makes no commitment to update or to keep current the contained information, or to notify a person or organization of any update. Union reserves the right to make changes, at any time, in order to improve reliability, function or design and to attempt to supply the best product possible.



Union Semiconductor, Inc

Add: Unit 606, No.570 Shengxia Road, Shanghai 201210

Tel: 021-51093966

Fax: 021-51026018

Website: www.union-ic.com