

500mA, Micropower, VLDO Linear Regulator**UM1770Y-xx SOT89-5****UM1770DA-xx DFN6 2.0×2.0****General Description**

The UM1770 series are VLDO (very low dropout) linear regulators designed for low power portable applications. Typical output noise is only $90\mu\text{V}_{\text{RMS}}$ (Fixed Output, $V_{\text{OUT}}=1.0\text{V}$) and maximum dropout is just 320mV at the load current of 500mA. The internal P-channel MOSFET pass transistor requires no base current, allowing the device to draw only 250 μA during normal operation at the maximum load current of 500mA.

Other features include high output voltage accuracy, excellent transient response, under voltage lockout, stability with ultra low ESR ceramic capacitors as small as 1 μF , short-circuit and thermal overload protection and output current limiting.

The UM1770Y-xx series are available in SOT89-5 package and the UM1770DA-xx series are available in a low profile DFN6 2.0×2.0 package.

Applications

- Bluetooth/802.11 Cards
- PDAs and Notebook Computers
- Portable Instruments and Battery-Powered Systems
- Cellular Phones

Features

- Very Low Dropout: 320mV (Max) at 500mA
- Maximum Input Voltage: 6.0V
- Low Noise (10Hz to 100kHz):
 $90\mu\text{V}_{\text{RMS}}$ (Fixed Output, $V_{\text{OUT}}=1.0\text{V}$);
 $60\mu\text{V}_{\text{RMS}}$ (Adjustable Output, $V_{\text{OUT}}=1.0\text{V}$);
 $194\mu\text{V}_{\text{RMS}}$ (Adjustable Output, $V_{\text{OUT}}=3.3\text{V}$);
 $305\mu\text{V}_{\text{RMS}}$ (Adjustable Output, $V_{\text{OUT}}=5.0\text{V}$)
- $\pm 2\%$ Voltage Accuracy at 500mA
- Fast Transient Response
- Under Voltage Lockout
- Fixed Output Voltage of UM1770Y/DA-xx:
1.0V to 4.0V with 0.1V Interval
- Adjustable Output Voltage of
UM1770Y/DA-00:
1.0V to 5.0V
- Output Current Limit
- Stable with 1 μF Output Capacitor
- Short-Circuit and Thermal Overload Protection
- Low Profile SOT89-5 and DFN6 2.0×2.0 Packages

Pin Configurations

Top View

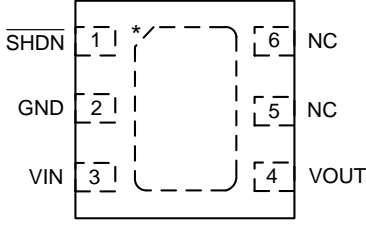
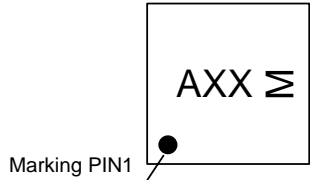
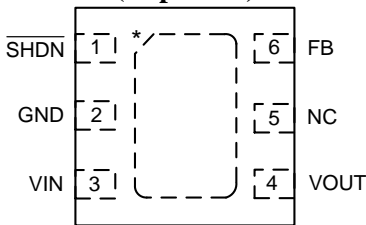
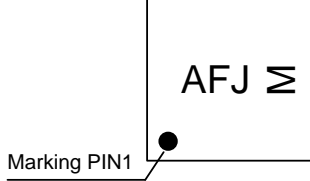
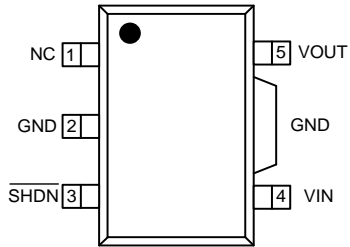
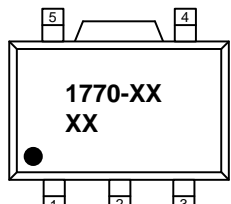
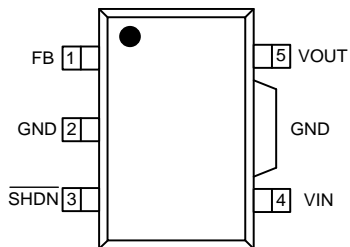
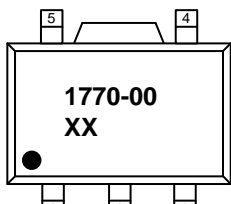
<p style="text-align: center;">(Top View)</p> 	 <p style="text-align: center;"> M: Month Code UM1770DA-xx DFN6 2.0x2.0 </p>
<p style="text-align: center;">(Top View)</p> 	 <p style="text-align: center;"> M: Month Code UM1770DA-00 DFN6 2.0x2.0 </p>
	 <p style="text-align: center;"> XX: Week Code UM1770Y-xx SOT89-5 </p>
	 <p style="text-align: center;"> XX: Week Code UM1770Y-00 SOT89-5 </p>

* The tab on the bottom of the package enhances thermal performance and is electrically connected to GND (substrate level). It is recommended that the tab be connected to the ground plane on the board. If not, the tab can be left open.

Pin Description

Pin Number (Fixed V _{OUT})		Pin Number (Adjustable V _{OUT})		Symbol	Function
DFN6 2.0×2.0	SOT89-5	DFN6 2.0×2.0	SOT89-5		
1	3	1	3	$\overline{\text{SHDN}}$	Shutdown Input: High=Activate LDO, Low=Shutdown LDO
2	2	2	2	GND	Ground
3	4	3	4	VIN	Power Supply
4	5	4	5	VOUT	Voltage Regulated Output
5, 6	1	5	-	NC	Not Connected
-	-	6	1	FB	Output Voltage Feedback

Naming Information

UM1770 □ □ - □ □

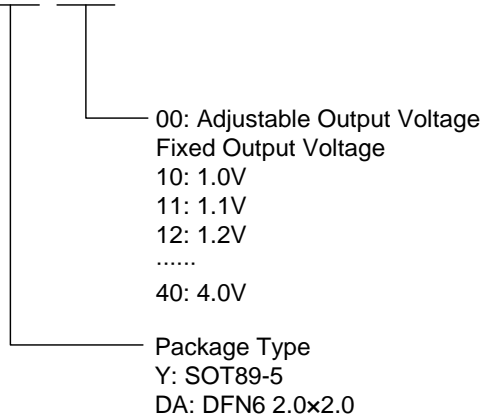

Ordering Information

Part Number	Output Voltage	Packaging Type	Marking Code	Shipping Qty
UM1770Y-00	ADJ	SOT89-5	1770-00	1000pcs/7Inch Tape & Reel
UM1770Y-10	1.0V		1770-10	
UM1770Y-11	1.1V		1770-11	
UM1770Y-12	1.2V		1770-12	
UM1770Y-13	1.3V		1770-13	
UM1770Y-14	1.4V		1770-14	
UM1770Y-15	1.5V		1770-15	
UM1770Y-16	1.6V		1770-16	
UM1770Y-17	1.7V		1770-17	
UM1770Y-18	1.8V		1770-18	
UM1770Y-19	1.9V		1770-19	
UM1770Y-20	2.0V		1770-20	
UM1770Y-21	2.1V		1770-21	
UM1770Y-22	2.2V		1770-22	
UM1770Y-23	2.3V		1770-23	
UM1770Y-24	2.4V		1770-24	
UM1770Y-25	2.5V		1770-25	
UM1770Y-26	2.6V		1770-26	
UM1770Y-27	2.7V		1770-27	
UM1770Y-28	2.8V		1770-28	
UM1770Y-29	2.9V		1770-29	
UM1770Y-30	3.0V		1770-30	
UM1770Y-31	3.1V		1770-31	
UM1770Y-32	3.2V		1770-32	
UM1770Y-33	3.3V		1770-33	
UM1770Y-34	3.4V		1770-34	
UM1770Y-35	3.5V		1770-35	
UM1770Y-36	3.6V		1770-36	
UM1770Y-37	3.7V		1770-37	
UM1770Y-38	3.8V		1770-38	
UM1770Y-39	3.9V		1770-39	
UM1770Y-40	4.0V		1770-40	

Ordering Information (Continued)

Part Number	Output Voltage	Packaging Type	Marking Code	Shipping Qty
UM1770DA-00	ADJ	DFN6 2.0x2.0	AFJ	3000pcs/7Inch Tape & Reel
UM1770DA-10	1.0V		AAS	
UM1770DA-11	1.1V		AAT	
UM1770DA-12	1.2V		AAC	
UM1770DA-13	1.3V		AAD	
UM1770DA-14	1.4V		AAU	
UM1770DA-15	1.5V		AAJ	
UM1770DA-16	1.6V		AFE	
UM1770DA-17	1.7V		AFF	
UM1770DA-18	1.8V		AAK	
UM1770DA-19	1.9V		AFG	
UM1770DA-20	2.0V		AFH	
UM1770DA-21	2.1V		AFK	
UM1770DA-22	2.2V		AFL	
UM1770DA-23	2.3V		AFN	
UM1770DA-24	2.4V		AFP	
UM1770DA-25	2.5V		AAN	
UM1770DA-26	2.6V		AFQ	
UM1770DA-27	2.7V		AFR	
UM1770DA-28	2.8V		AAQ	
UM1770DA-29	2.9V		AFS	
UM1770DA-30	3.0V		AAR	
UM1770DA-31	3.1V		AFT	
UM1770DA-32	3.2V		AFU	
UM1770DA-33	3.3V		AAV	
UM1770DA-34	3.4V		AFV	
UM1770DA-35	3.5V		AAZ	
UM1770DA-36	3.6V		AFZ	
UM1770DA-37	3.7V		AGL	
UM1770DA-38	3.8V		AGN	
UM1770DA-39	3.9V		AGP	
UM1770DA-40	4.0V		AGQ	

Absolute Maximum Ratings (Note 1)

Symbol	Parameter	Value	Unit	
V_{IN}	Supply Voltage on VIN Pin	-0.3 to +7.5	V	
$V_{\overline{SHDN}}$	Voltage on \overline{SHDN} Pin	-0.3 to +7.5	V	
V_{OUT}	Voltage on VOUT Pin	-0.3 to +7.5	V	
V_{FB}	Voltage on FB Pin	-0.3 to +7.5	V	
T_J	Operating Junction Temperature (Note 2, 3)	-40 to +125	°C	
T_{STG}	Storage Temperature Range	-65 to +150	°C	
T_L	Lead Temperature for Soldering 10 Seconds	+300	°C	
P_D (Note 4)	Power Dissipation @ 25°C	DFN6 2.0×2.0	0.9	W
		SOT89-5	1.5	
θ_{JA}	Package Thermal Resistance	DFN6 2.0×2.0	110	°C/W
		SOT89-5	66	

Note 1: Absolute Maximum Ratings are those values beyond which the life of a device may be impaired.

Note 2: The UM1770 is tested and specified under pulse load conditions such that $T_J \approx T_A$. Specifications over the -40°C to 125°C operating junction temperature range are assured by design, characterization and correlation with statistical process controls.

Note 3: This IC includes over-temperature protection that is intended to protect the device during momentary overload conditions. Junction temperature will exceed 125°C when over-temperature protection is active. Continuous operation above the specified maximum operating junction temperature may impair device reliability.

Note 4: The maximum allowable power dissipation of any T_A (ambient temperature) is $P_{D\text{MAX}} = (T_{J\text{MAX}} - T_A) / \theta_{JA}$. Exceeding the maximum allowable power dissipation will result in excessive die temperature and the regulator will go into thermal shutdown.

Electrical Characteristics

Over recommended operating free-air temperature range (unless otherwise noted)

Symbol	Parameter	Test Conditions	Min	Typ	Max	Unit
V_{IN}	Input Voltage Range		2.5		6.0	V
V_{UVLO}	Input Under Voltage Lockout	V_{IN} Falling	1.8		2.4	V
I_Q	Operating Quiescent Current	$V_{IN}=4.2V, I_{OUT}=0mA$		92	140	μA
		$V_{IN}=4.2V, I_{OUT}=500mA$		250	300	
I_{SHDN}	Shutdown Leakage Current				1	μA
I_{OUT}	Output Current		500			mA
	Output Voltage Accuracy	$1mA \leq I_{OUT} \leq 500mA, T_A = -25^\circ C$	-2		+2	%
ΔV_{DO}	Dropout Voltage	$I_{OUT}=500mA, 2.5V \leq V_{OUT}$		220	320	mV
I_{LIMIT}	Output Current Limit	$V_{IN} \geq 2.5V$	700			mA
t	Startup Time Response	$R_L=68\Omega, C_{OUT}=1\mu F$		40		μs
V_{IL}	\overline{SHDN} Input Low Voltage	$2.5V \leq V_{IN} \leq 6.0V$			0.4	V
V_{IH}	\overline{SHDN} Input High Voltage	$2.5V \leq V_{IN} \leq 6.0V$	2.0			V
	\overline{SHDN} Input Current	$\overline{SHDN}=V_{IN}$ or GND	-1		+1	μA
T_{SHDN}	Thermal-Shutdown Temperature			160		$^\circ C$
ΔT_{SHDN}	Thermal-Shutdown Hysteresis			25		$^\circ C$
	Line Regulation	$V_{OUT}+1V \leq V_{IN} \leq 6.0V$ ($2.5V \leq V_{IN}$) $I_{OUT}=10mA$		0.09		%/V
	Load Regulation	$V_{IN}=V_{OUT}+1V$ ($2.5V \leq V_{IN}$) $1mA \leq I_{OUT} \leq 500mA$		0.2		%
	Output Voltage Noise	10Hz to 100kHz, $C_{IN}=1.0\mu F,$ $I_{OUT}=100mA$	Fixed Output, $V_{OUT}=1.0V$	90		μV_{RMS}
			Adjustable Output, $V_{OUT}=1.0V$	60		
			Adjustable Output, $V_{OUT}=3.3V$	194		
			Adjustable Output, $V_{OUT}=5.0V$	305		
PSRR	Power Supply Ripple Rejection	$V_{IN}=V_{OUT}+1V$ $I_{OUT}=10mA$	f=100Hz	65		dB
			f=1kHz	60		
			f=10kHz	45		

Typical Characteristics (shown for 1.1V output option)
 ($C_{IN}=1.0\mu F$, $C_{OUT}=1.0\mu F$, $T_A=25^\circ C$, unless otherwise specified.)

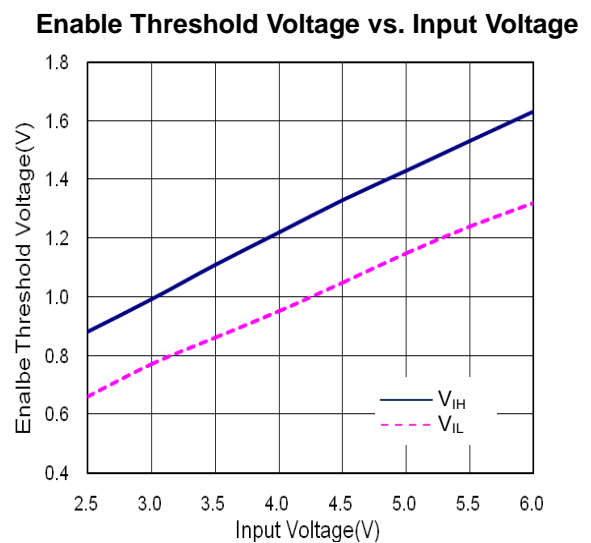
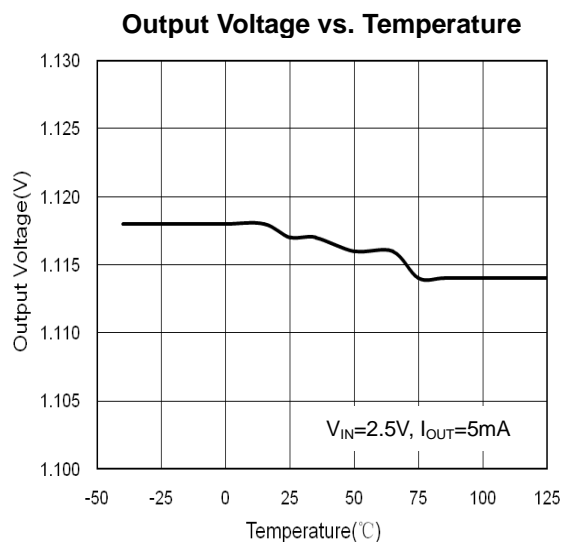
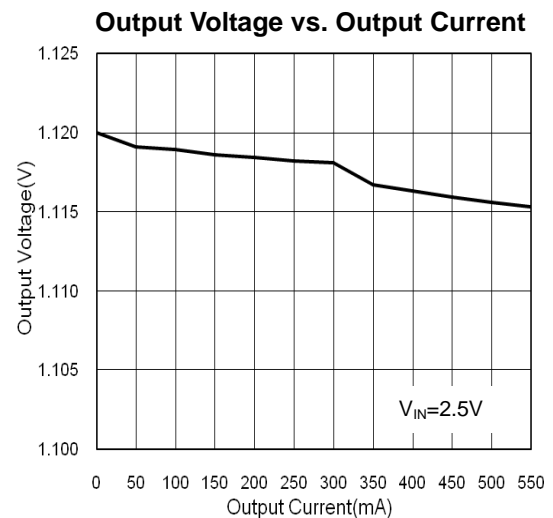
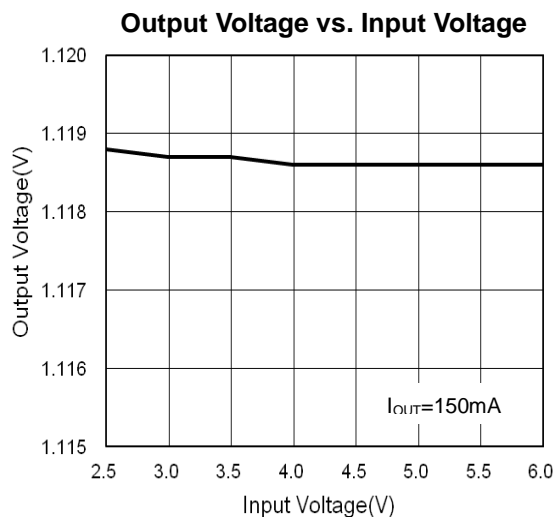
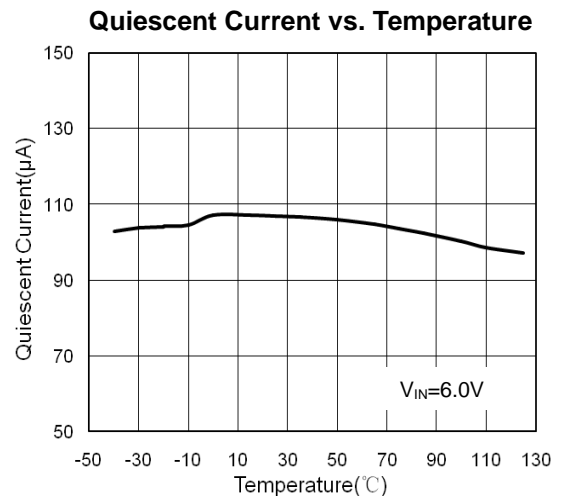
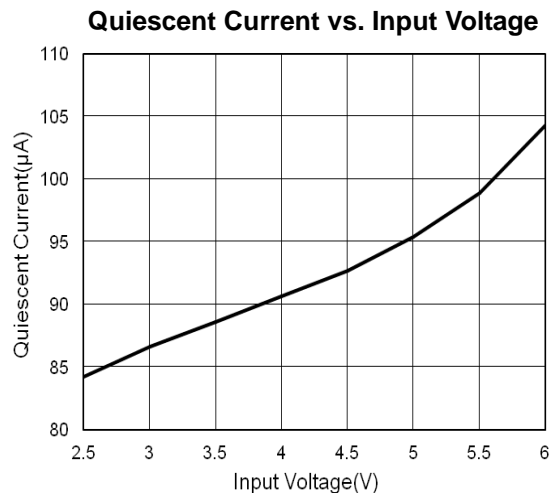

Typical Characteristics (shown for 1.1V output option) (Continued)
($C_{IN}=1.0\mu F$, $C_{OUT}=1.0\mu F$, $T_A=25^\circ C$, unless otherwise specified.)

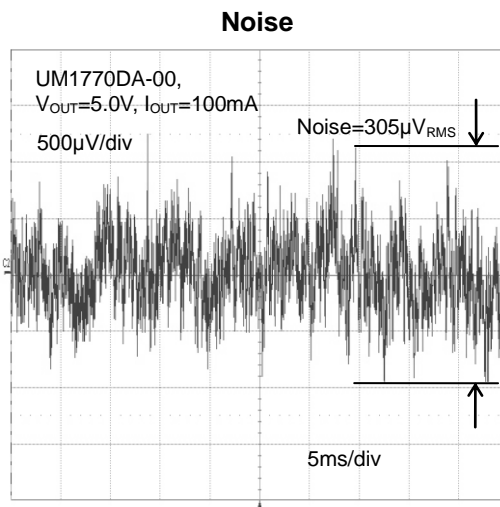
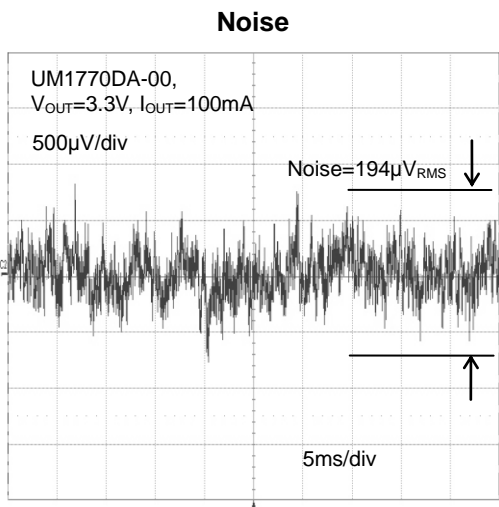
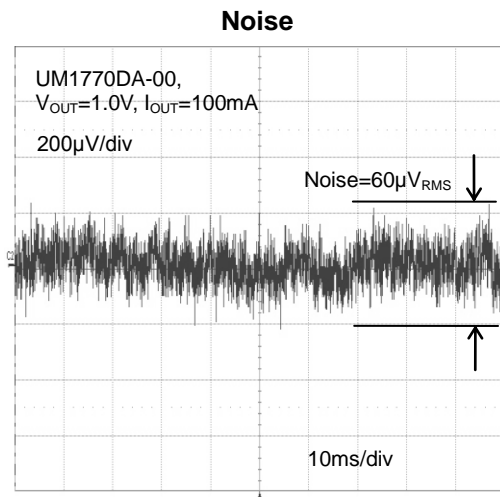
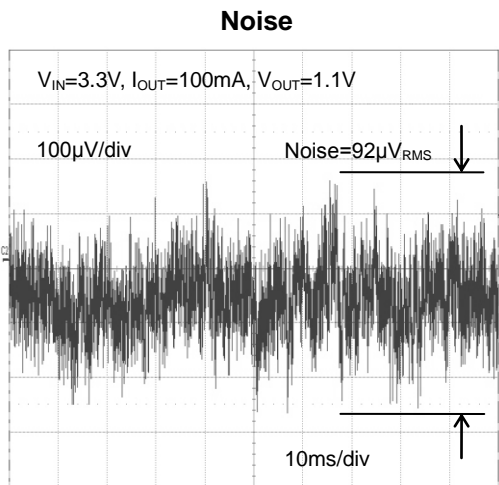
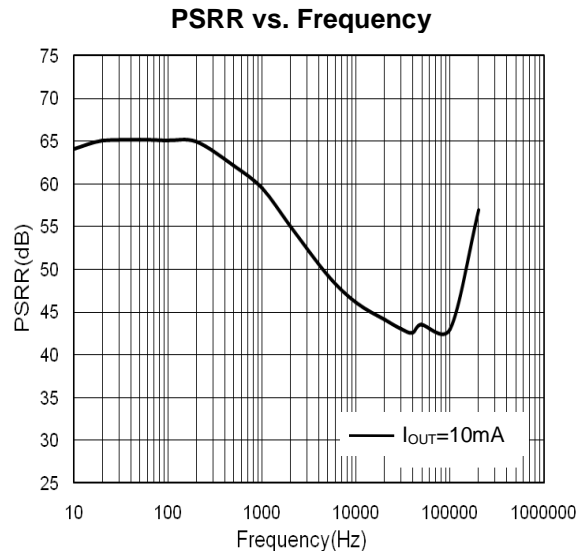
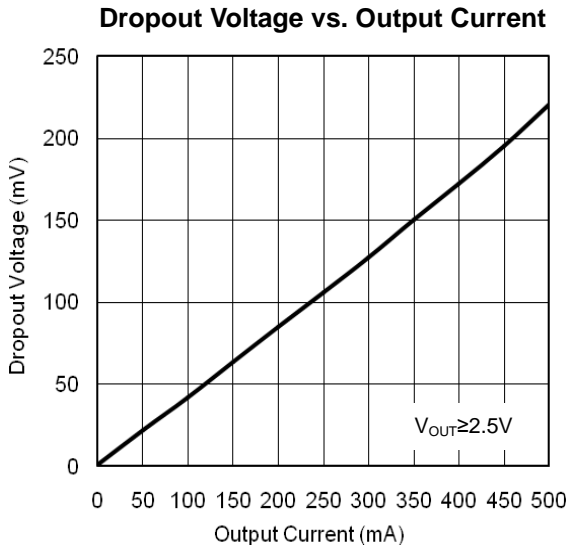

Typical Characteristics (shown for 1.1V output option) (Continued)
 ($C_{IN}=1.0\mu F$, $C_{OUT}=1.0\mu F$, $T_A=25^\circ C$, unless otherwise specified.)

Load Transient Response

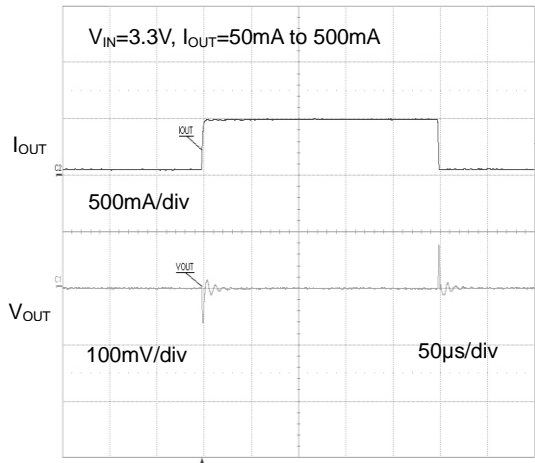

Line Transient Response

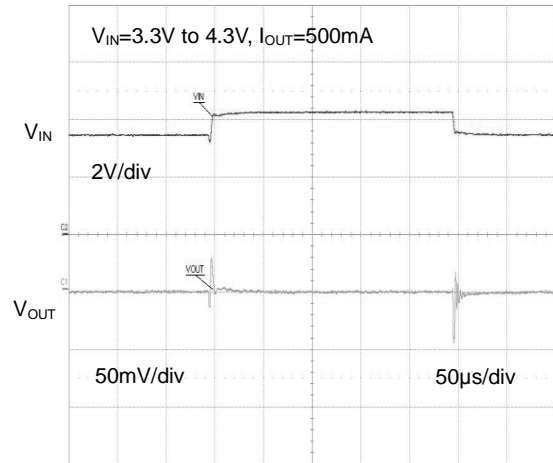

Startup Waveform

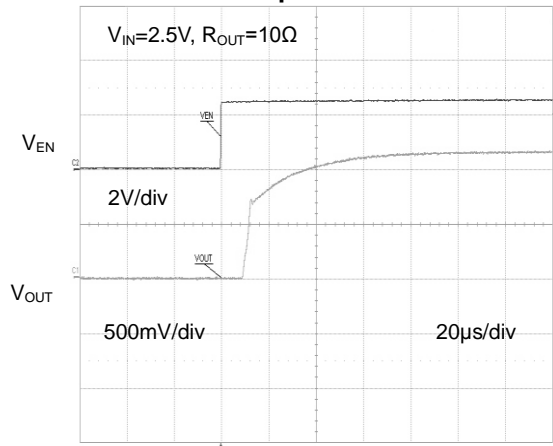

Shutdown Waveform

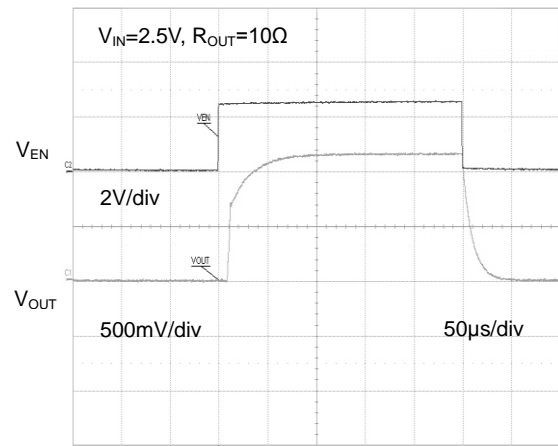

Pin Function

SHDN: Shutdown, Active Low. This pin is used to put the UM1770 into shutdown. The SHDN pin cannot be left floating and must be tied to the input pin if not used.

GND: Ground and Heat Sink. Solder to a ground plane or large pad to maximize heat dissipation.

VIN: Power for UM1770 and Load. Power is supplied to the devices through the VIN pin. The VIN pin should be locally bypassed to ground if the UM1770 series are more than a few inches away from another source of bulk capacitance.

VOUT: Voltage Regulated Output. The VOUT pin supplies power to the load. A minimum output capacitor of 1µF is required to ensure stability. Larger output capacitors may be required for applications with large transient loads to limit peak voltage transients.

NC: Not Connected.

FB: Output voltage feedback. This terminal is used to set the output voltage.

Output Voltage Setting

The output voltage of the UM1770 adjustable regulator is programmed using an external resistor divider as shown in Figure 2. The output voltage is calculated using:

$$V_{OUT} = V_{FB} \left(1 + \frac{R1}{R2} \right)$$

Where: $V_{FB}=1.00V$ (Typ) (the internal reference voltage)

Resistors R1 and R2 should be chosen for approximately 3-5µA divider current. Lower value resistors can be used but offer no inherent advantage and waste more power. Higher values should be avoided, as leakage currents at FB increase the output voltage error. The recommended design procedure is to choose $R2=200k\Omega$ to set the divider current at 5µA and then calculate R1 using:

$$R1 = \left(\frac{V_{OUT}}{V_{FB}} - 1 \right) \times R2$$

Where: $V_{FB}=1.00V$ (Typ).

Typical Application Circuit

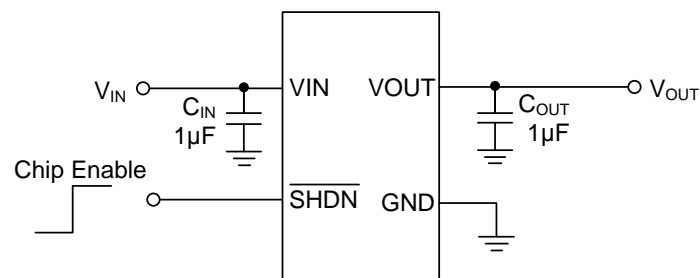

Figure 1. Fixed Output Voltage Application Circuit

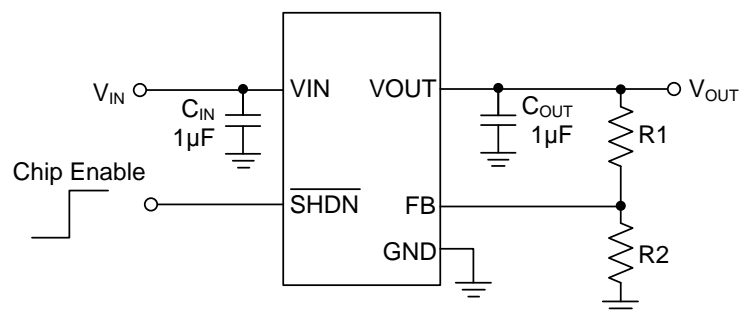
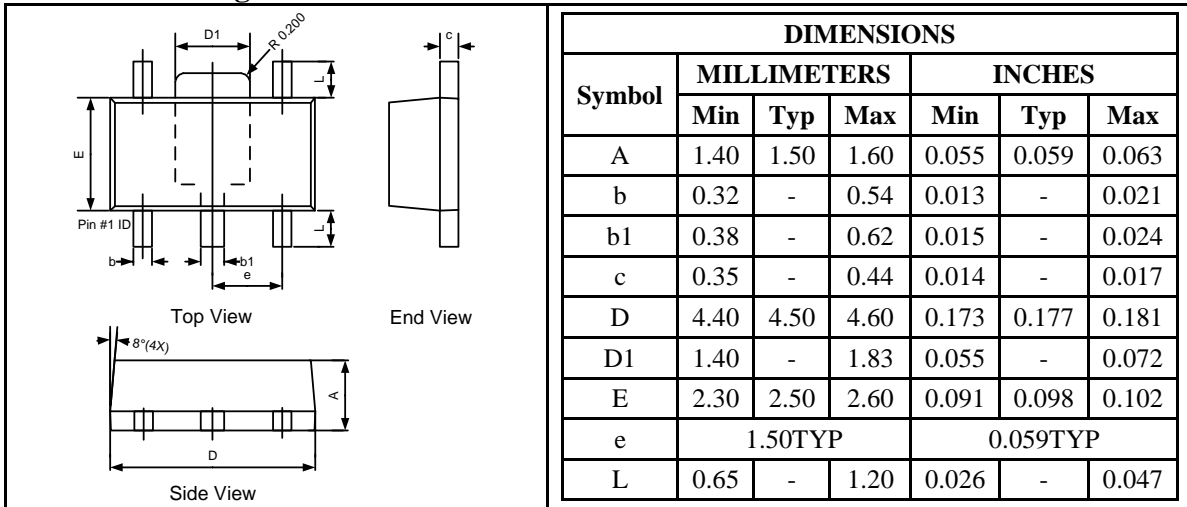

Figure 2. Adjustable Output Voltage Application Circuit

Package Information

UM1770Y-xx SOT89-5

Outline Drawing



Land Pattern

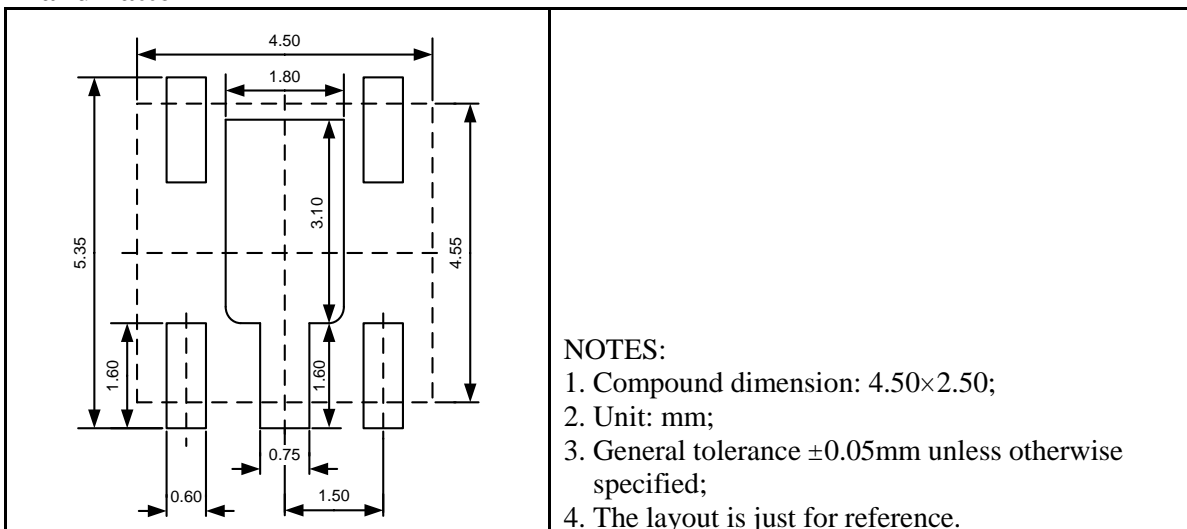

Tape and Reel Orientation



UM1770DA-xx DFN6 2.0×2.0

Outline Drawing

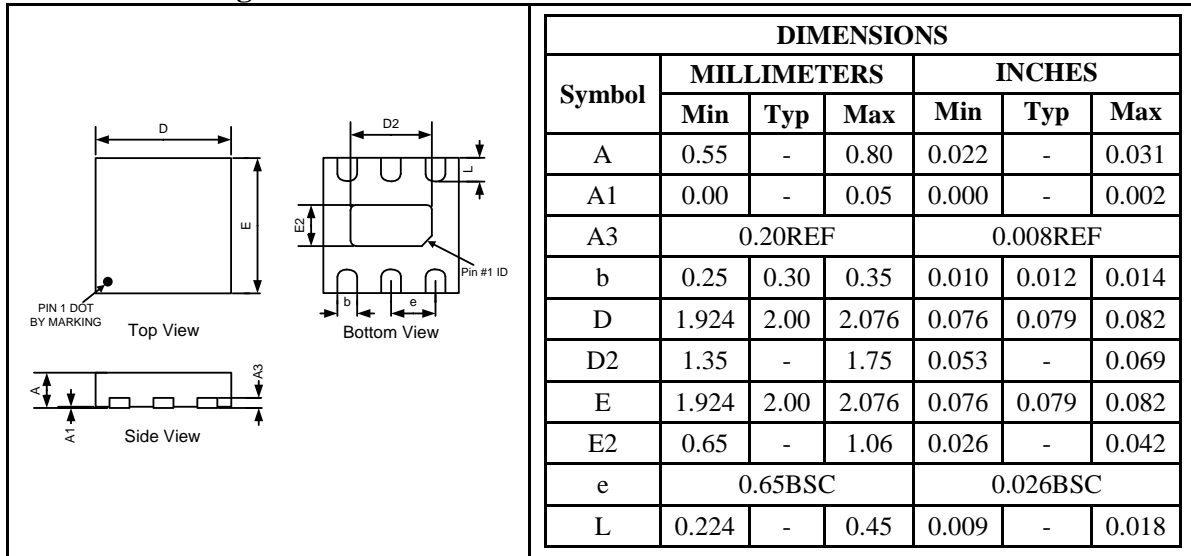

Land Pattern

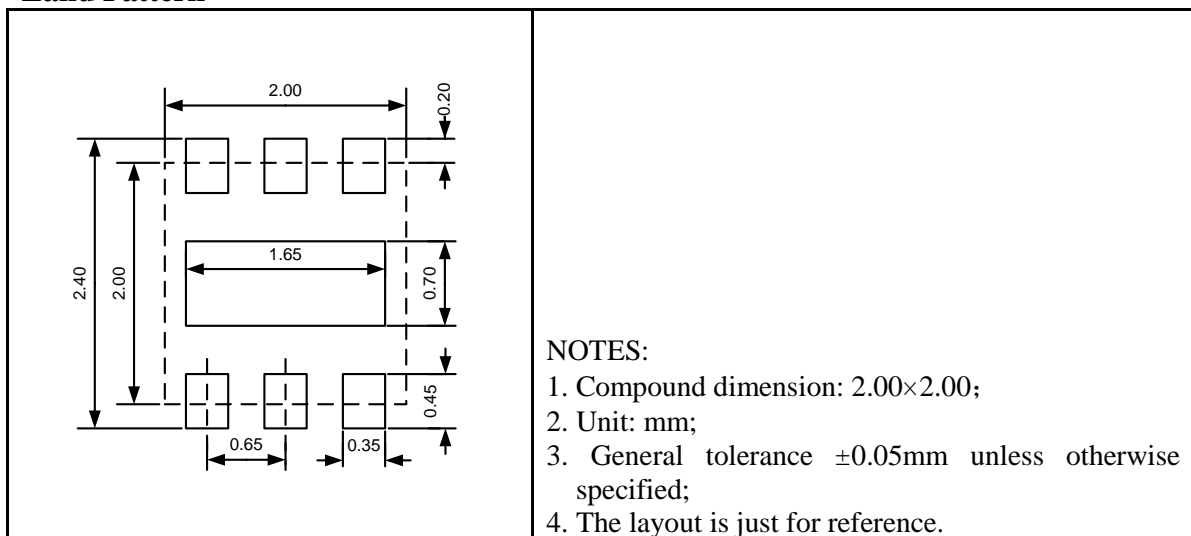

Tape and Reel Orientation



GREEN COMPLIANCE

Union Semiconductor is committed to environmental excellence in all aspects of its operations including meeting or exceeding regulatory requirements with respect to the use of hazardous substances. Numerous successful programs have been implemented to reduce the use of hazardous substances and/or emissions.

All Union components are compliant with the RoHS directive, which helps to support customers in their compliance with environmental directives. For more green compliance information, please visit:

http://www.union-ic.com/index.aspx?cat_code=RoHSDeclaration

IMPORTANT NOTICE

The information in this document has been carefully reviewed and is believed to be accurate. Nonetheless, this document is subject to change without notice. Union assumes no responsibility for any inaccuracies that may be contained in this document, and makes no commitment to update or to keep current the contained information, or to notify a person or organization of any update. Union reserves the right to make changes, at any time, in order to improve reliability, function or design and to attempt to supply the best product possible.



Union Semiconductor, Inc

Add: Unit 606, No.570 Shengxia Road, Shanghai 201210

Tel: 021-51093966

Fax: 021-51026018

Website: www.union-ic.com