

## 5V Input, Low Quiescent Current Linear Regulator

**UM1530S SOT23-3**

**UM1530DA DFN6 2.0×2.0**

**UM1530DB DFN4 1.0×1.0**

**UM1540S SOT23-5**

**UM1540DA DFN6 2.0×2.0**

**UM1540DB DFN4 1.0×1.0**

### General Description

The UM1530/1540 series is a set of high input voltage low quiescent current regulator implemented in CMOS technology. They can deliver 300mA output current and allow an input voltage as high as 6V. They are available with several fixed output voltages ranging from 1.2V to 5.0V. CMOS technology ensures low voltage drop and low quiescent current.

The UM1530 is available in SOT23-3, DFN6 2.0×2.0 and DFN4 1.0×1.0 packages. The UM1540 is available in SOT23-5, DFN6 2.0×2.0 and DFN4 1.0×1.0 packages.

### Applications

- Communication Equipments
- Audio/Video Equipments
- Portable Games
- Portable AV Equipments
- Battery-Powered Equipments

### Features

- Input Voltage Range: 1.8V to 6V
- 300mA Guaranteed Output Current
- Low Dropout Voltage: 250mV (Typical) at 200mA
- Low Quiescent Current: 1  $\mu$ A @  $V_{IN}=5V$  (Typical)
- Low Noise: 500  $\mu$ V<sub>RMS</sub> (10Hz to 100kHz)
- Available Fixed Output Voltage from 1.2V to 5.0V with 0.1V Step
- With Shutdown Control (UM1540)
- Output Current Limit
- Low Profile SOT23-3, SOT23-5, DFN6 2.0×2.0 and DFN4 1.0×1.0 Packages

### Typical Application Circuits

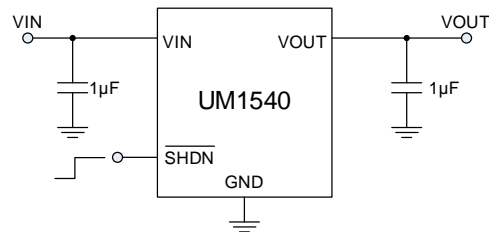
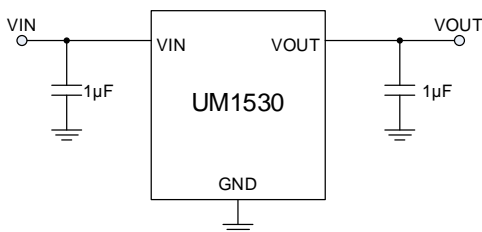

**Pin Configurations**

**Top View**

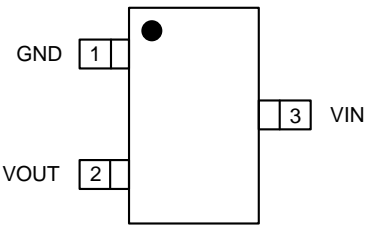
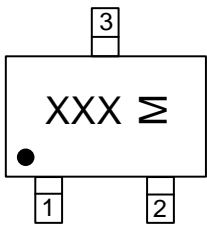
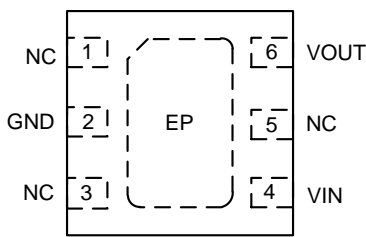
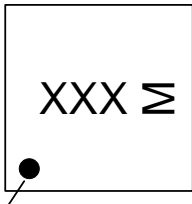
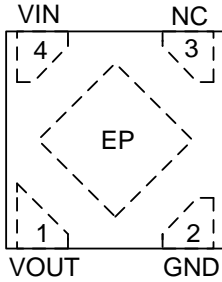
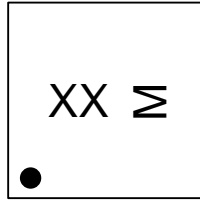
 <p style="text-align: center;"><b>UM1530S</b></p>	 <p style="text-align: center;"><b>M: Month Code UM1530S SOT23-3</b></p>
<p style="text-align: center;"><b>(Top View)</b></p>  <p style="text-align: center;"><b>UM1530DA</b></p>	 <p style="text-align: center;"><b>M: Month Code UM1530DA DFN6 2.0×2.0</b></p>
<p style="text-align: center;"><b>(Top View)</b></p>  <p style="text-align: center;"><b>UM1530DB</b></p>	 <p style="text-align: center;"><b>M: Month Code UM1530DB DFN4 1.0×1.0</b></p>

Pin Configurations

Top View

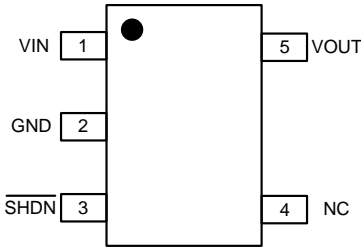
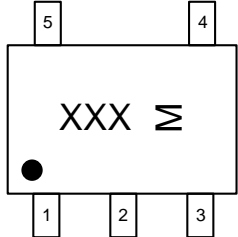
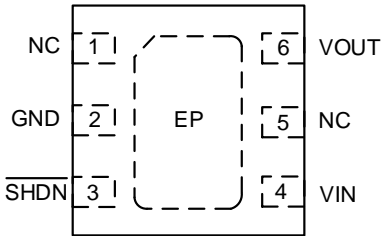
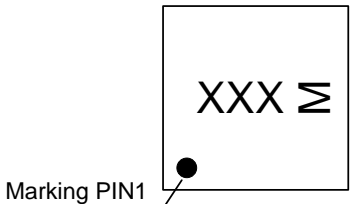
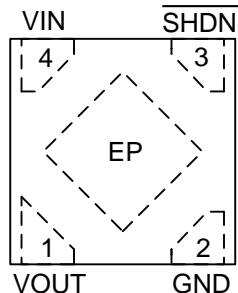
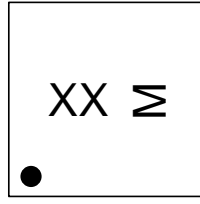
 <p style="text-align: center;"><b>UM1540S</b></p>	 <p style="text-align: center;"><b>M: Month Code UM1540S SOT23-5</b></p>
<p style="text-align: center;"><b>(Top View)</b></p>  <p style="text-align: center;"><b>UM1540DA</b></p>	 <p style="text-align: center;"><b>M: Month Code UM1540DA DFN6 2.0×2.0</b></p>
<p style="text-align: center;"><b>(Top View)</b></p>  <p style="text-align: center;"><b>UM1540DB</b></p>	 <p style="text-align: center;"><b>M: Month Code UM1540DB DFN4 1.0×1.0</b></p>

**Pin Description**

Name	Pin						Description
	SOT23-3	SOT23-5	DFN6		DFN4		
	UM1530S	UM1540S	UM1530DA	UM1540DA	UM1530DB	UM1540DB	
GND	1	2	2	2	2	2	Ground
V <sub>OUT</sub>	2	5	6	6	1	1	Voltage Regulated Output
V <sub>IN</sub>	3	1	4	4	4	4	Supply Input
NC	-	4	1,3,5	1,5	3	-	Not Connected
$\overline{\text{SHDN}}$	-	3	-	3	-	3	Shutdown Control Input: High=Activate LDO, Low=Shutdown LDO
EP	-	-					Exposed Pad. Connect to ground

**Naming Information**

UM1530 □ □ - □ □  
 UM1540 □ □ - □ □

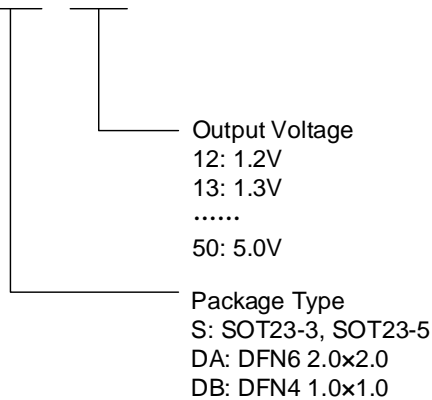

**Absolute Maximum Ratings (Note 1)**

Symbol	Parameter	Value	Unit	
V <sub>IN</sub>	Supply Voltage on V <sub>IN</sub> Pin	-0.3 to +6.5	V	
V <sub>OUT</sub>	Voltage on V <sub>OUT</sub> Pin	-0.3 to +6.5	V	
T <sub>J</sub>	Operating Junction Temperature (Note 2, 3)	-40 to +125	°C	
T <sub>STG</sub>	Storage Temperature Range	-65 to +150	°C	
T <sub>L</sub>	Lead Temperature for Soldering 10 Seconds	+260	°C	
P <sub>D</sub> (Note 4)	Power Dissipation@25 °C	SOT23-3	0.40	W
		SOT23-5	0.43	
		DFN6 2.0×2.0	0.9	
		DFN4 1.0×1.0	0.4	
θ <sub>JA</sub>	Package Thermal Resistance	SOT23-3	250	°C/W
		SOT23-5	230	
		DFN6 2.0×2.0	110	
		DFN4 1.0×1.0	250	

Note 1: Absolute Maximum Ratings are those values beyond which the life of a device may be impaired.

Note 2: The UM1530/1540 is tested and specified under pulse load conditions such that  $T_J \approx T_A$ . Specifications over the -40 °C to 125 °C operating junction temperature range are assured by design, characterization and correlation with statistical process controls.

Note 3: This IC includes over temperature protection that is intended to protect the device during momentary overload conditions. Junction temperature will exceed 125 °C when over temperature protection is active. Continuous operation above the specified maximum operating junction temperature may impair device reliability.

Note 4: The maximum allowable power dissipation of any T<sub>A</sub> (ambient temperature) is  $P_{DMAX} = (T_{JMAX} - T_A) / \theta_{JA}$ . Exceeding the maximum allowable power dissipation will result in excessive die temperature and the regulator will go into thermal shutdown.

**Electrical Characteristics**
 $V_{IN} = V_{OUT} + 1V$ ,  $C_{IN} = C_{OUT} = 1\mu F$ ,  $T_A = 25\text{ }^\circ\text{C}$ .

Symbol	Parameter	Test Conditions	Min	Typ	Max	Unit
$V_{IN}$	Input Voltage Range		1.8		6	V
$V_{OUT}$	Output Voltage Range		1.2		5.0	V
$I_Q$	Operating Quiescent Current	$V_{IN} = 5V$ , $I_{OUT} = 0mA$		1	1.5	$\mu A$
	Shut Down Quiescent Current	$V_{IN} = 5V$ , $\overline{SHDN} = GND$			1	$\mu A$
$I_{\overline{SHDN}}$	$\overline{SHDN}$ Input Current	$\overline{SHDN} = V_{IN}$ or GND			1	$\mu A$
$I_{OUT}$	Output Current		300			mA
	Output Voltage Accuracy	$1mA \leq I_{OUT} \leq 250mA$	-2.5		+2.5	%
$\Delta V_{DO}$	Dropout Voltage	$I_{OUT} = 200mA$		250	330	mV
$I_{LIMIT}$	Output Current Limit	$R_L = 1\Omega$	350	450	550	mA
t	Startup Time Response	$V_{OUT} = 3.3V$ , $R_L = 68\Omega$ , $C_{OUT} = 1\mu F$		150		$\mu s$
$V_{IL}$	$\overline{SHDN}$ Input Low Voltage	$V_{IN} = 1.8V$ to 5V			0.4	V
$V_{IH}$	$\overline{SHDN}$ Input High Voltage	$V_{IN} = 1.8V$ to 5V	1.2			V
	Output Voltage TC	-40 $^\circ\text{C}$ to +125 $^\circ\text{C}$		60		ppm/ $^\circ\text{C}$
	Line Regulation	$V_{OUT} + 0.3V \leq V_{IN} \leq 5V$ or $V_{IN} > 1.8V$ $I_{OUT} = 10mA$			0.3	%/V
	Load Regulation	$V_{IN} = V_{OUT} + 1V$ or $V_{IN} > 1.8V$ $1mA \leq I_{OUT} \leq 250mA$			0.6	%
	Output Voltage Noise	$V_{OUT} = 3.0V$ , $f = 10Hz$ to 100kHz, $C_{IN} = 1\mu F$ , $I_{OUT} = 100mA$		500		$\mu V_{RMS}$
PSRR	Power Supply Ripple Rejection	$V_{IN} = V_{OUT} + 1V$ $I_{OUT} = 100mA$	f=100Hz		56	dB
			f=1kHz		42	
	ESD Rating	Human Body Mode	2			kV

### Typical Performance Characteristics

$T_A = +25^{\circ}\text{C}$ ,  $V_{IN} = V_{OUT(NOM)} + 1\text{V}$ ,  $C_{IN} = 1\mu\text{F}$  and  $C_{OUT} = 1\mu\text{F}$ , unless otherwise noted.

**Line Transient Response**

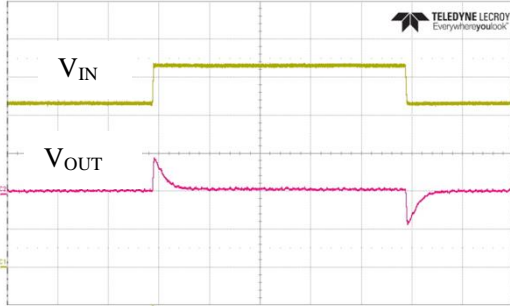

$V_{IN}$ : 1V/div,  $V_{OUT}$ : 100mV/div, Time: 50us/div  
 $V_{IN}=4.3\text{V}$  to  $5.3\text{V}$ ,  $I_{OUT}=110\text{mA}$

**Load Transient Response**

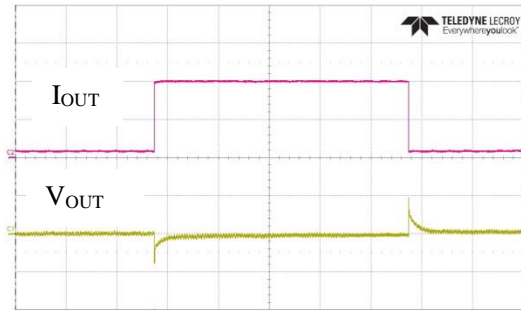

$I_{OUT}$ : 100mA/div,  $V_{OUT}$ : 100mV/div, Time: 1ms/div  
 $V_{IN}=4.3\text{V}$ ,  $I_{OUT}=20\text{mA}$  to  $200\text{mA}$

**Quiescent Current vs. Input Voltage**

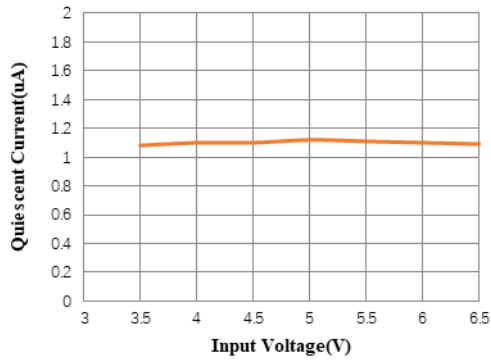

**Quiescent Current vs. Temperature**

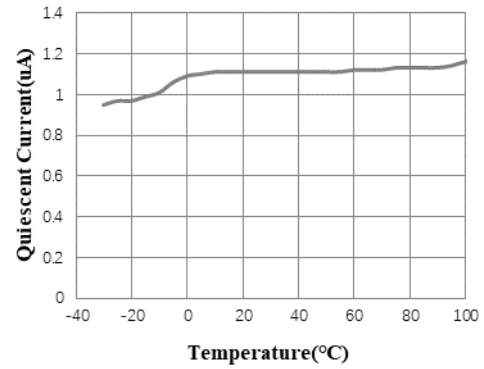

**Ground Pin Current vs. Output Current**

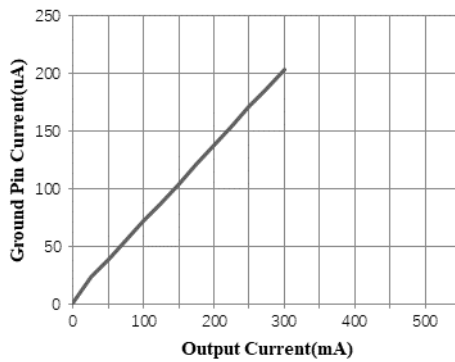

**Dropout Voltage vs. Output Current**

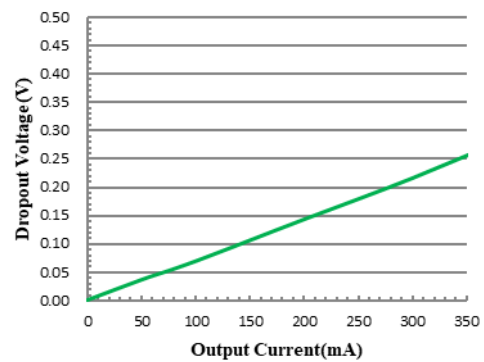

**Typical Performance Characteristics (continued)**

$T_A = +25^\circ\text{C}$ ,  $V_{IN} = V_{OUT(NOM)} + 1\text{V}$ ,  $C_{IN} = 1\mu\text{F}$  and  $C_{OUT} = 1\mu\text{F}$ , unless otherwise noted.

**Output Voltage vs. Input Voltage**

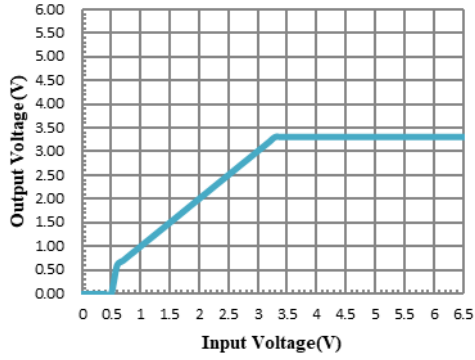

**Output Voltage vs. Temperature**

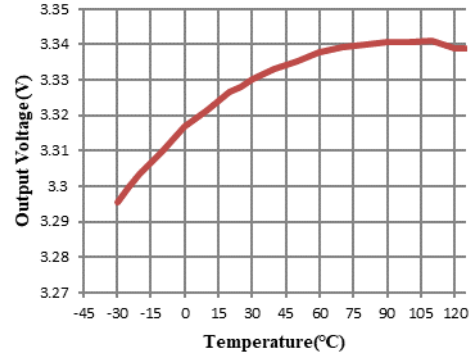



Package Information

SOT23-3

Outline Drawing

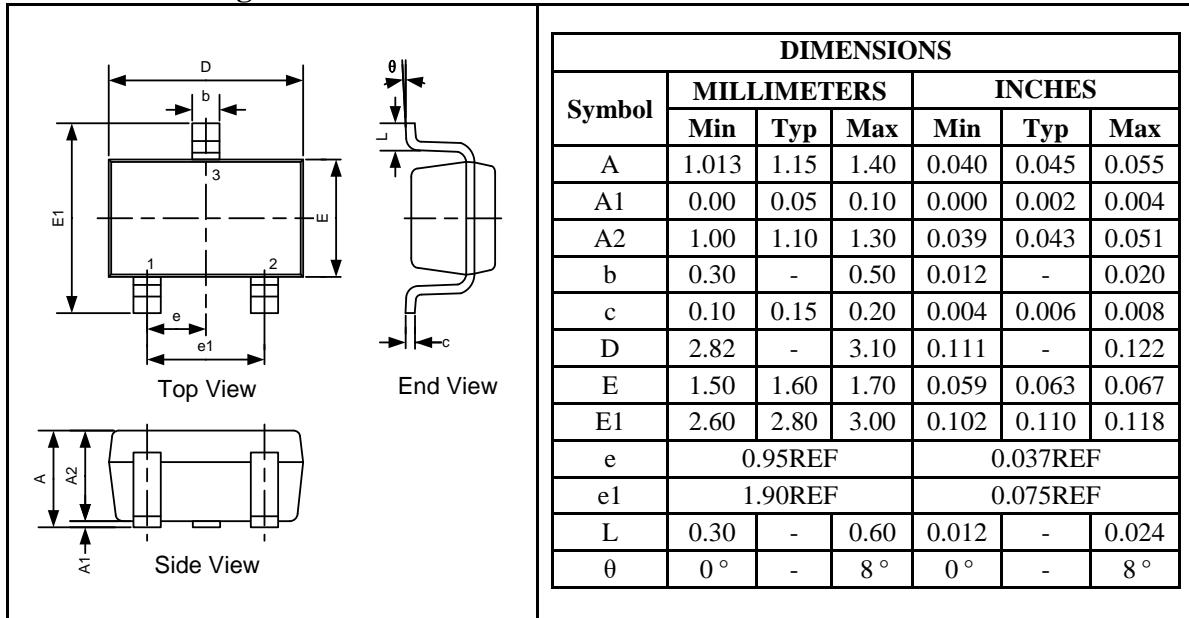

Land Pattern

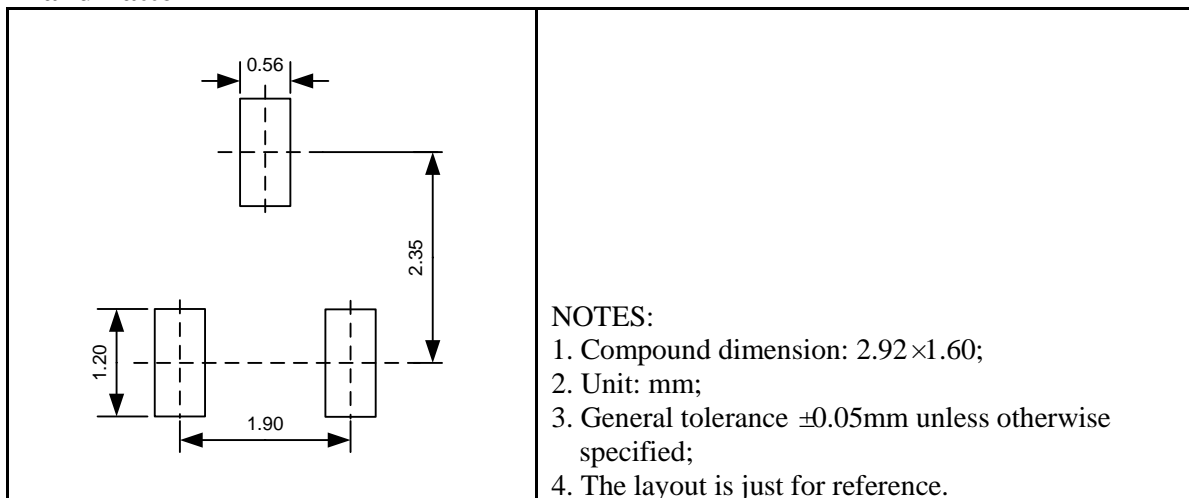

**DFN6 2.0×2.0**

**Outline Drawing**

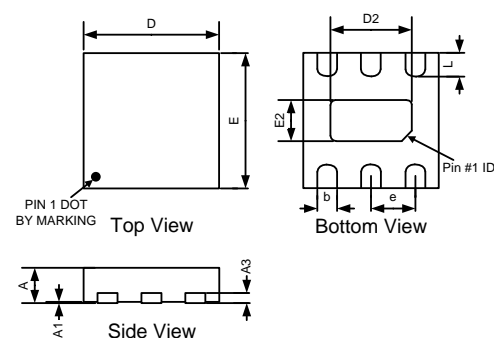

PIN 1 DOT BY MARKING

Top View

Bottom View

Side View

DIMENSIONS						
Symbol	MILLIMETERS			INCHES		
	Min	Typ	Max	Min	Typ	Max
A	0.55	-	0.80	0.022	-	0.031
A1	0.00	-	0.05	0.000	-	0.002
A3	0.20REF			0.008REF		
b	0.25	0.30	0.35	0.010	0.012	0.014
D	1.924	2.00	2.076	0.076	0.079	0.082
D2	1.35	-	1.75	0.053	-	0.069
E	1.924	2.00	2.076	0.076	0.079	0.082
E2	0.65	-	1.06	0.026	-	0.042
e	0.65BSC			0.026BSC		
L	0.224	-	0.45	0.009	-	0.018

**Land Pattern**

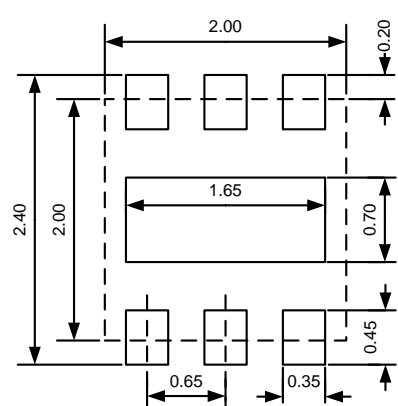

NOTES:

1. Compound dimension: 2.00×2.00 ;
2. Unit: mm;
3. General tolerance ±0.05mm unless otherwise specified;
4. The layout is just for reference.

**DFN4 1.0×1.0**

**Outline Drawing**

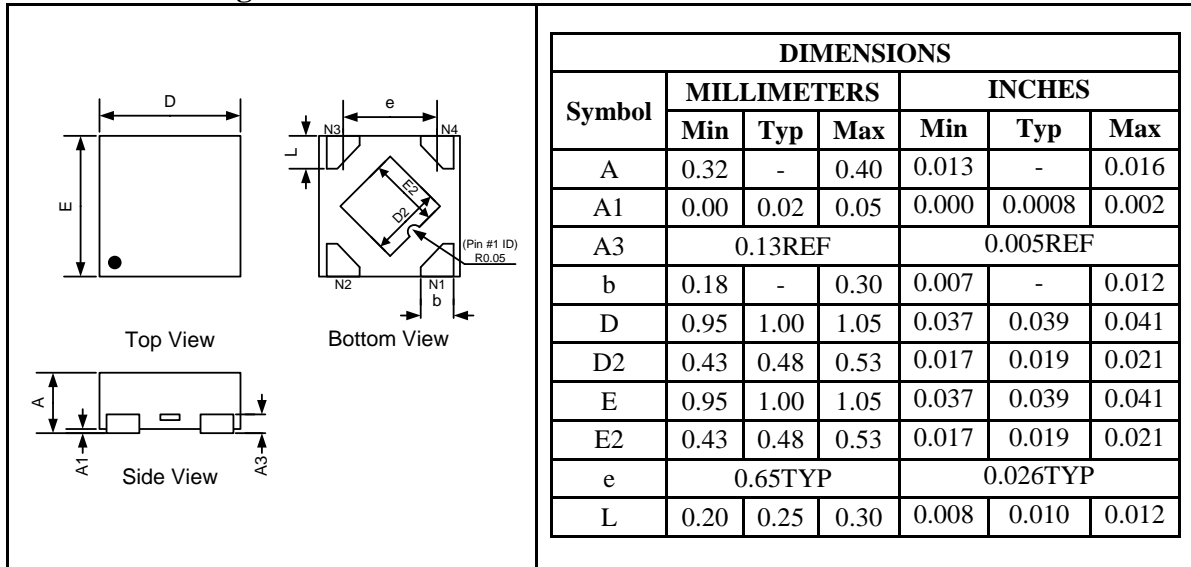

**Land Pattern**

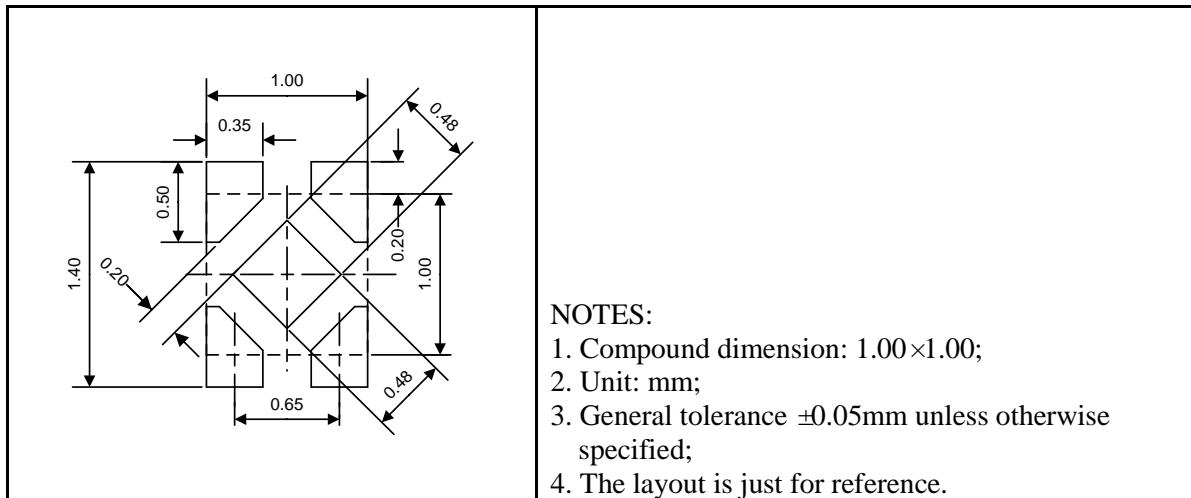

SOT23-5

Outline Drawing

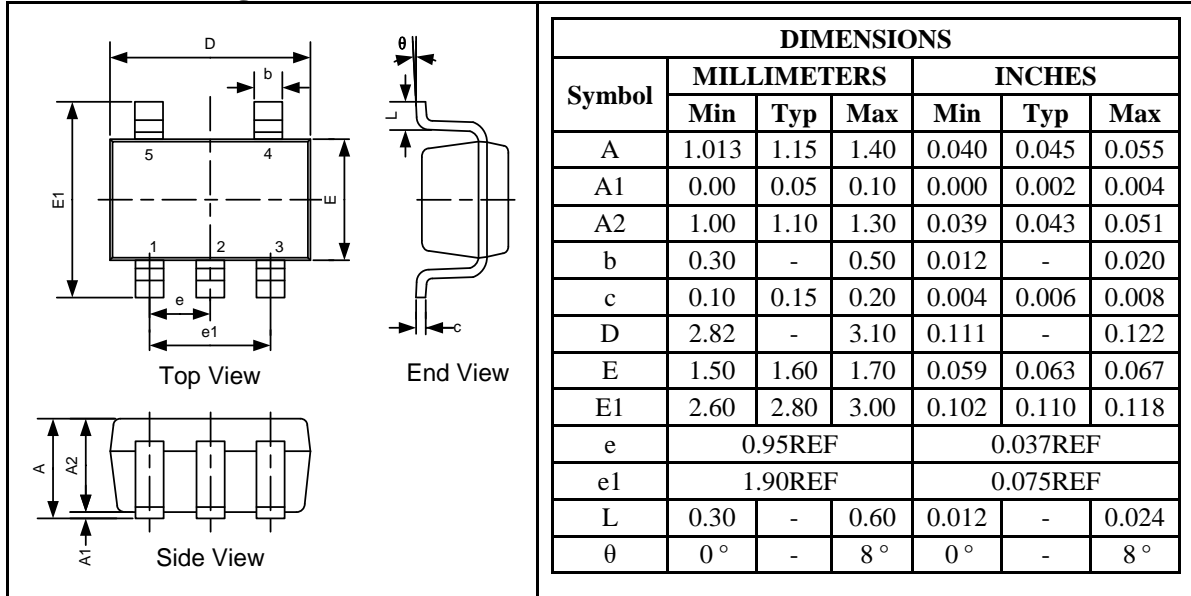

Land Pattern

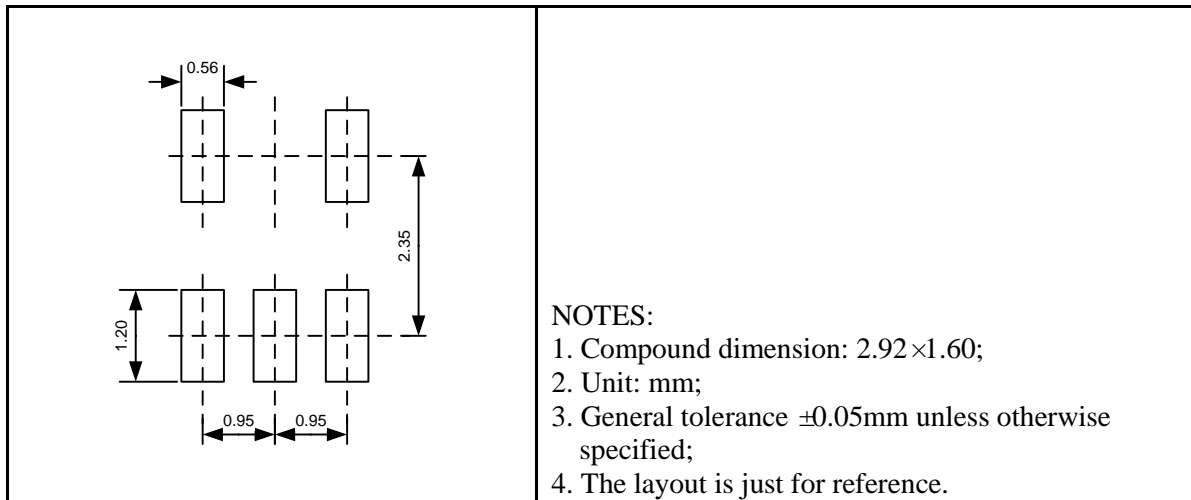

## Packing Information

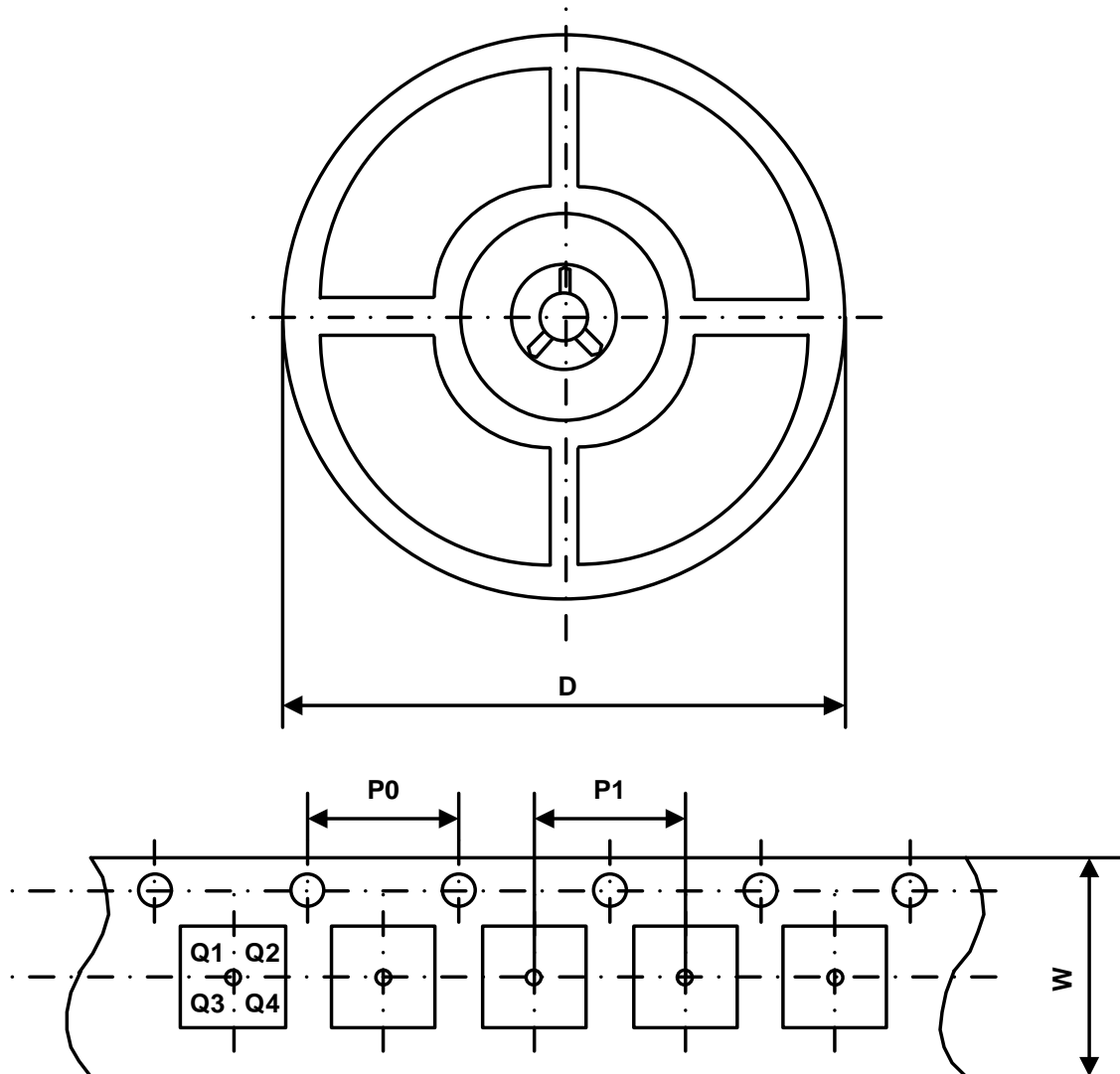

Part Number	Package Type	Carrier Width (W)	Pitch (P0)	Pitch (P1)	Reel Size (D)	PIN 1 Quadrant
UM1530S	SOT23-3	8 mm	4 mm	4 mm	180 mm	Q3
UM1530DA	DFN6 2.0×2.0	8 mm	4 mm	4 mm	180 mm	Q1
UM1530DB	DFN4 1.0×1.0	8 mm	4 mm	4 mm	180 mm	Q1
UM1540S	SOT23-5	8 mm	4 mm	4 mm	180 mm	Q3
UM1540DA	DFN6 2.0×2.0	8 mm	4 mm	4 mm	180 mm	Q1
UM1540DB	DFN4 1.0×1.0	8 mm	4 mm	4 mm	180 mm	Q1

**Ordering Information**

Part Number	Output Voltage	Marking Code	Package	Shipping Qty
UM1530S-12	1.2V	UC2	SOT23-3	3000pcs/7Inch Tape & Reel
UM1530S-13	1.3V	UC3		
UM1530S-15	1.5V	UC5		
UM1530S-18	1.8V	UC8		
UM1530S-25	2.5V	UD5		
UM1530S-27	2.7V	UD7		
UM1530S-28	2.8V	UD8		
UM1530S-30	3.0V	UDA		
UM1530S-31	3.1V	UGB		
UM1530S-33	3.3V	UG3		
UM1530S-35	3.5V	UG5		
UM1530S-36	3.6V	UG6		
UM1530S-38	3.8V	UG8		
UM1530S-40	4.0V	UGA		
UM1530S-42	4.2V	UI2		
UM1530S-43	4.3V	UI3		
UM1530S-45	4.5V	UI5		
UM1530S-47	4.7V	UI7		
UM1530S-48	4.8V	UI8		
UM1530S-50	5.0V	UIA		

**Ordering Information (Continued)**

Part Number	Output Voltage	Marking Code	Package	Shipping Qty
UM1530DA-12	1.2V	BFC	DFN6 2.0×2.0	3000pcs/7Inch Tape & Reel
UM1530DA-13	1.3V	AND		
UM1530DA-15	1.5V	ANE		
UM1530DA-18	1.8V	ANF		
UM1530DA-25	2.5V	ANG		
UM1530DA-27	2.7V	ANH		
UM1530DA-28	2.8V	ANJ		
UM1530DA-30	3.0V	ANK		
UM1530DA-31	3.1V	BFB		
UM1530DA-33	3.3V	ANL		
UM1530DA-35	3.5V	ANN		
UM1530DA-36	3.6V	ANP		
UM1530DA-38	3.8V	ANQ		
UM1530DA-40	4.0V	ANR		
UM1530DA-42	4.2V	ANS		
UM1530DA-43	4.3V	ANT		
UM1530DA-45	4.5V	ANU		
UM1530DA-47	4.7V	ANV		
UM1530DA-48	4.8V	ANZ		
UM1530DA-50	5.0V	BFD		

**Ordering Information (Continued)**

Part Number	Output Voltage	Marking Code	Package	Shipping Qty
UM1530DB-12	1.2V	NA	DFN4 1.0×1.0	3000pcs/7Inch Tape & Reel
UM1530DB-13	1.3V	DC		
UM1530DB-15	1.5V	DD		
UM1530DB-18	1.8V	DE		
UM1530DB-25	2.5V	DF		
UM1530DB-27	2.7V	DG		
UM1530DB-28	2.8V	DH		
UM1530DB-30	3.0V	DJ		
UM1530DB-31	3.1V	NJ		
UM1530DB-33	3.3V	DK		
UM1530DB-35	3.5V	DL		
UM1530DB-36	3.6V	DN		
UM1530DB-38	3.8V	DP		
UM1530DB-40	4.0V	DQ		
UM1530DB-42	4.2V	DR		
UM1530DB-43	4.3V	DS		
UM1530DB-45	4.5V	DT		
UM1530DB-47	4.7V	DU		
UM1530DB-48	4.8V	DV		
UM1530DB-50	5.0V	DZ		



**Ordering Information (Continued)**

Part Number	Output Voltage	Marking Code	Package	Shipping Qty
UM1540S-12	1.2V	5F3	SOT23-5	3000pcs/7Inch Tape & Reel
UM1540S-13	1.3V	5FB		
UM1540S-15	1.5V	5FC		
UM1540S-18	1.8V	5FD		
UM1540S-25	2.5V	5FE		
UM1540S-27	2.7V	5FF		
UM1540S-28	2.8V	5FH		
UM1540S-30	3.0V	5FL		
UM1540S-31	3.1V	5HH		
UM1540S-33	3.3V	5FM		
UM1540S-35	3.5V	5FJ		
UM1540S-36	3.6V	5FK		
UM1540S-38	3.8V	5FN		
UM1540S-40	4.0V	5FP		
UM1540S-42	4.2V	5FQ		
UM1540S-43	4.3V	5FR		
UM1540S-45	4.5V	5FS		
UM1540S-47	4.7V	5FT		
UM1540S-48	4.8V	5FY		
UM1540S-50	5.0V	5FU		

**Ordering Information (Continued)**

Part Number	Output Voltage	Marking Code	Package	Shipping Qty
UM1540DA-12	1.2V	AA4	DFN6 2.0×2.0	3000pcs/7Inch Tape & Reel
UM1540DA-13	1.3V	AG2		
UM1540DA-15	1.5V	AG3		
UM1540DA-18	1.8V	AG4		
UM1540DA-25	2.5V	AG5		
UM1540DA-27	2.7V	AG6		
UM1540DA-28	2.8V	AG7		
UM1540DA-30	3.0V	AG8		
UM1540DA-31	3.1V	AGS		
UM1540DA-33	3.3V	AG9		
UM1540DA-35	3.5V	AGA		
UM1540DA-36	3.6V	AGB		
UM1540DA-38	3.8V	AGC		
UM1540DA-40	4.0V	AGD		
UM1540DA-42	4.2V	AGE		
UM1540DA-43	4.3V	AGF		
UM1540DA-45	4.5V	AGG		
UM1540DA-47	4.7V	AGH		
UM1540DA-48	4.8V	AGJ		
UM1540DA-50	5.0V	AGK		

**Ordering Information (Continued)**

Part Number	Output Voltage	Marking Code	Package	Shipping Qty
UM1540DB-12	1.2V	HC	DFN4 1.0×1.0	3000pcs/7Inch Tape & Reel
UM1540DB-13	1.3V	FC		
UM1540DB-15	1.5V	FD		
UM1540DB-18	1.8V	FE		
UM1540DB-25	2.5V	FF		
UM1540DB-27	2.7V	FG		
UM1540DB-28	2.8V	FH		
UM1540DB-30	3.0V	FJ		
UM1540DB-31	3.1V	N4		
UM1540DB-33	3.3V	FK		
UM1540DB-35	3.5V	FL		
UM1540DB-36	3.6V	FN		
UM1540DB-38	3.8V	FP		
UM1540DB-40	4.0V	FQ		
UM1540DB-42	4.2V	FR		
UM1540DB-43	4.3V	FS		
UM1540DB-45	4.5V	FT		
UM1540DB-47	4.7V	FU		
UM1540DB-48	4.8V	FV		
UM1540DB-50	5.0V	FZ		

---

## GREEN COMPLIANCE

Union Semiconductor is committed to environmental excellence in all aspects of its operations including meeting or exceeding regulatory requirements with respect to the use of hazardous substances. Numerous successful programs have been implemented to reduce the use of hazardous substances and/or emissions.

All Union components are compliant with the RoHS directive, which helps to support customers in their compliance with environmental directives. For more green compliance information, please visit:

[http://www.union-ic.com/index.aspx?cat\\_code=RoHSDeclaration](http://www.union-ic.com/index.aspx?cat_code=RoHSDeclaration)

## IMPORTANT NOTICE

The information in this document has been carefully reviewed and is believed to be accurate. Nonetheless, this document is subject to change without notice. Union assumes no responsibility for any inaccuracies that may be contained in this document, and makes no commitment to update or to keep current the contained information, or to notify a person or organization of any update. Union reserves the right to make changes, at any time, in order to improve reliability, function or design and to attempt to supply the best product possible.