

**3.0V to 5.5V, 10Mbps, Fail-Safe, Hot-Swap, RS-485  
Transceivers**

**UM13088S8 SOP8**

**UM13088M8 MSOP8**

**UM13088DA DFN8 3.0×3.0**

**General Description**

The UM13088 are high-speed transceivers for RS-485 communication that contain one driver and one receiver. These devices feature fail-safe circuitry, which guarantees a logic-high receiver output when the receiver inputs are open, shorted or idle. This means that the receiver output will be logic high if all transmitters on a terminated bus are disabled (high impedance). The UM13088 driver slew rates are not limited, making transmit speeds up to 10Mbps possible.

The transceivers typically draw 650µA of supply current when unloaded, or when fully loaded with the drivers disabled. All devices have a 1/8-unit-load receiver input impedance that allows up to 256 transceivers on the bus and are intended for half-duplex communications.

**Applications**

- RS-485 Transceivers
- Level Translators
- Industrial-Control Local Area Networks
- Telecommunications
- Security Systems
- Instrumentation

**Features**

- Data Rates up to 10 Mbps
- True Fail-Safe Receiver while Maintaining EIA/TIA-485 Compatibility
- -7V to +12V Common-Mode Input Voltage Range
- Allows up to 256 Transceivers on the Bus
- Thermal Shutdown
- Current-Limiting for Driver Overload Protection

**Ordering Information**

Part Number	Temp. Range	Marking Code	Package Type	Shipping Qty
UM13088S8	-40 °C to +85 °C	UM13088S8	SOP8	3000pcs/13 Inch Tape & Reel
UM13088M8	-40 °C to +85 °C	13088	MSOP8	4000pcs/13 Inch Tape & Reel
UM13088DA	-40 °C to +85 °C	13088	DFN8 3.0×3.0	3000pcs/13 Inch Tape & Reel

**Selection Guide**

Part Number	Guaranteed Date Rate (Mbps)	Low-Power Shutdown	Slew-Rate Limited	Driver/Receiver Enable	Transceivers On Bus
UM13088S8	10	Yes	No	Yes	256
UM13088M8	10	Yes	No	Yes	256
UM13088DA	10	Yes	No	Yes	256

## Pin Configurations

## Top View

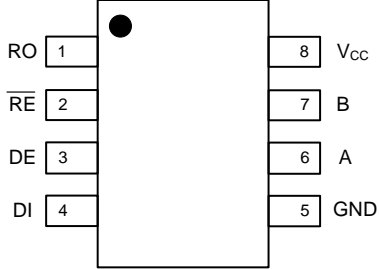
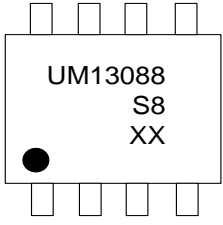
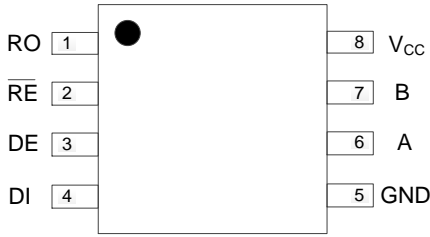
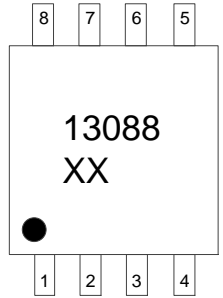
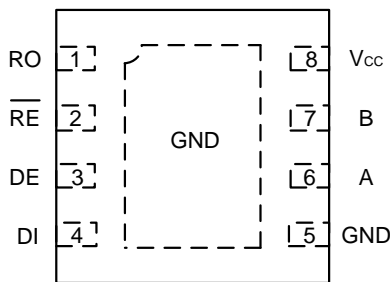
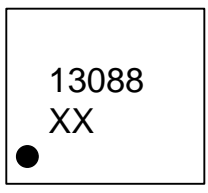
	 <p><b>XX: Week Code</b> <b>UM13088S8</b> <b>SOP8</b></p>
	 <p><b>XX: Week Code</b> <b>UM13088M8</b> <b>MSOP8</b></p>
	 <p><b>XX: Week Code</b> <b>UM13088DA</b> <b>DFN8 3.0x3.0</b></p>

**Pin Description**

Pin Number	Symbol	Function
1	RO	Receiver Output. If $A > B$ by $-50\text{mV}$ , RO will be high; if $A < B$ by $-200\text{mV}$ , RO will be low.
2	$\overline{\text{RE}}$	Receiver Output Enable. Drive $\overline{\text{RE}}$ low to enable Receiver, RO is high impedance when $\overline{\text{RE}}$ is high. Drive $\overline{\text{RE}}$ high and DE low to enter low-power shutdown mode.
3	DE	Driver Enable. Drive DE high to enable drivers. The outputs are high impedance when DE is low. Drive $\overline{\text{RE}}$ high and DE low to enter low-power shutdown mode.
4	DI	Driver Input. A low on DI forces output A low and output B high. Similarly, a high on DI forces output A high and output B low.
5	GND	Ground.
6	A	Non-Inverting Receiver Input and Non-Inverting Driver Output.
7	B	Inverting Receiver Input and Inverting Driver Output.
8	$V_{\text{CC}}$	Power Supply for RS-485 Transceiver.

**Absolute Maximum Ratings**

Symbol	Parameter	Value	Unit
$V_{\text{CC}}$	Supply Voltage	+6	V
	Control Input Voltage ( $\overline{\text{RE}}$ , DE)	$-0.3\text{V}$ to $(V_{\text{CC}} + 0.3\text{V})$	V
	Driver Input Voltage (DI)	$-0.3\text{V}$ to $(V_{\text{CC}} + 0.3\text{V})$	V
	Driver Output Voltage (A, B)	$-7.5$ to $+12.5$	V
	Receiver Input Voltage (A, B)	$-7.5$ to $+12.5$	V
	Receiver Output Voltage (RO)	$-0.3\text{V}$ to $(V_{\text{CC}} + 0.3\text{V})$	V
$T_{\text{A}}$	Ambient Temperature	$-40$ to $+85$	$^{\circ}\text{C}$
$T_{\text{J}}$	Operating Junction Temperature	$-40$ to $+125$	$^{\circ}\text{C}$
$T_{\text{STG}}$	Storage Temperature Range	$-65$ to $+150$	$^{\circ}\text{C}$
$T_{\text{L}}$	Lead Temperature for Soldering 10 seconds	+260	$^{\circ}\text{C}$

**Package Thermal Impedance**

Symbol	Parameter	Value	Unit
$R_{\theta\text{JA}}$	Junction-to-ambient thermal resistance	SOP8	121
		MSOP8	165.69
		DFN8 3.0×3.0	47.6
$R_{\theta\text{JC(top)}}$	Junction-to-case (top) thermal resistance	SOP8	41
		MSOP8	49.61
		DFN8 3.0×3.0	49.4

**ESD Rating**

Symbol	Parameter	Value	Unit
ESD Protection	HBM - Human Body Model (RS-485 bus pins A, B)	±8	kV
	HBM - Human Body Model (all other pins)	±4	

**DC Electrical Characteristics**

( $V_{CC} = 3.0V$  to  $5.5V$ ,  $T_A = -40\text{ }^\circ\text{C}$  to  $+85\text{ }^\circ\text{C}$ , unless otherwise noted.) (Note 1)

Parameter	Symbol	Test Conditions	Min	Typ	Max	Unit
<b>Power Supply</b>						
Supply-Voltage Range	$V_{CC}$		3.0		5.5	V
Supply Current	$I_{CC}$	No Load, DI=GND or $V_{CC}$		0.65	1.3	mA
		DE= $V_{CC}$ , $\overline{RE}=0V$ or $V_{CC}$			0.6	
Supply Current in Shutdown Mode	$I_{SHDN}$	DE=GND, $\overline{RE}=V_{CC}$		1	10	$\mu\text{A}$
<b>Logic</b>						
Input High Voltage	$V_{IH}$	DE, DI, $\overline{RE}$	$2/3 * V_{CC}$			V
Input Low Voltage	$V_{IL}$	DE, DI, $\overline{RE}$			0.8	V
Input Hysteresis	$V_{HYS}$			300		mV
Logic Input Current	$I_{IN1}$	DE, DI, $\overline{RE}$	-1		1	$\mu\text{A}$
Receiver Output High Voltage (RO)	$V_{OH}$	$I_{OUT}=-1\text{mA}$	$V_{CC}-0.6$			V
Receiver Output Low Voltage (RO)	$V_{OL}$	$I_{OUT}=1\text{mA}$			0.4	V
<b>Driver</b>						
Differential Driver Output	$V_{OD1}$	No Load, Figure 2			$V_{CC}$	V
Differential Driver Output	$V_{OD2}$	$R_L=54\ \Omega$ , $V_{CC}=3.3V$	1.5			V
Change-in-Magnitude of Differential Output Voltage	$\Delta V_{OD}$	Figure 2, $R_L=54\ \Omega$ (Note 2)			0.2	V
Driver Common-Mode Output Voltage	$V_{OC}$	Figure 2, $R_L=54\ \Omega$		$V_{CC}/2$	3.0	V
Change-in-Magnitude of Common-Mode Voltage	$\Delta V_{OC}$	Figure 2, $R_L=54\ \Omega$ (Note 2)			0.2	V
Driver Short-Circuit Output Current (Note 3)	$I_{OSD}$	$V_{OUT}=-7V$		-250		mA
		$V_{OUT}=12V$		250		

**DC Electrical Characteristics (Continued)**

 ( $V_{CC} = 3.0V$  to  $5.5V$ ,  $T_A = -40\text{ }^{\circ}C$  to  $+85\text{ }^{\circ}C$ , unless otherwise noted.) (Note 1)

Parameter	Symbol	Test Conditions	Min	Typ	Max	Unit
<b>Receiver</b>						
Receiver Differential Threshold Voltage	$V_{TH}$	$-7V \leq V_{CM} \leq 12V$	-200		-50	mV
Receiver Input Hysteresis	$\Delta V_{TH}$	$V_{CM} = 0V$		25		mV
Receiver Input Resistance	$R_{IN}$	$-7V \leq V_{CM} \leq 12V$	96			k $\Omega$
Input Current (A and B)	$I_{IN2}$	DE=GND, V <sub>CC</sub> =GND or 3.3V	$V_{IN} = 12V$		1	mA
			$V_{IN} = -7V$	-0.8		
Three-State Output Current at Receiver	$I_{OZR}$	$0V \leq V_O \leq V_{CC}$			$\pm 1$	$\mu A$
Receiver Output Short Circuit Current	$I_{OSR}$	$0V \leq V_{RO} \leq V_{CC}$	$\pm 8$		$\pm 60$	mA

Note 1: All currents into the device are positive; all currents out of the device are negative. All voltages are referred to device ground unless otherwise noted.

Note 2:  $\Delta V_{OD}$  and  $\Delta V_{OC}$  are the changes in  $V_{OD}$  and  $V_{OC}$ , respectively, when the DI input changes state.

Note 3: Maximum current level applies to peak current just prior to fold back current limiting; minimum current level applies during current limiting.

**Switching Characteristics**

 ( $V_{CC} = 3.0V$  to  $5.5V$ ,  $T_A = -40\text{ }^\circ\text{C}$  to  $+85\text{ }^\circ\text{C}$ , unless otherwise noted.)

Parameter	Symbol	Test Conditions	Min	Typ	Max	Unit
Maximum Data Rate	$f_{MAX}$			10		Mbps
Driver Input-to-Output	$t_{DPLH}$	Figure 3 and 6, $R_{DIFF}=54\Omega$ , $C_{L1}=C_{L2}=50pF$	10	25	50	ns
	$t_{DPHL}$		10	25	50	
Driver Output Skew $ t_{DPLH} - t_{DPHL} $	$t_{DSKEW}$	Figure 3 and 6, $R_{DIFF}=54\Omega$ , $C_{L1}=C_{L2}=50pF$		5	10	ns
Driver Rise or Fall Time	$t_{DR}, t_{DF}$	Figure 3 and 6, $R_{DIFF}=54\Omega$ , $C_{L1}=C_{L2}=50pF$			15	ns
Driver Enable to Output High	$t_{DZH}$	Figure 4 and 7, $C_L=50pF$ , S2 Closed		40	70	ns
Driver Enable to Output Low	$t_{DZL}$	Figure 4 and 7, $C_L=50pF$ , S1 Closed		40	70	ns
Driver Disable Time from Low	$t_{DLZ}$	Figure 4 and 7, $C_L=50pF$ , S1 Closed		40	70	ns
Driver Disable Time from High	$t_{DHZ}$	Figure 4 and 7, $C_L=50pF$ , S2 Closed		40	70	ns
Receiver Input to Output	$t_{RPLH}, t_{RPHL}$	$C_L=15pF$ , Figure 8, $ V_{ID} \geq 2.0V$ , Rise and Fall Time of $V_{ID}\leq 15ns$	20	50	80	ns
Differential Receiver Skew $ t_{RPLH} - t_{RPHL} $	$t_{RSKD}$	$C_L=15pF$ , Figure 8, $ V_{ID} \geq 2.0V$ , Rise and Fall Time of $V_{ID}\leq 15ns$		8	15	ns
Receiver Enable to Output Low	$t_{RZL}$	Figure 5 and 9, $C_L=15pF$ , S1 Closed		25	50	ns
Receiver Enable to Output High	$t_{RZH}$	Figure 5 and 9, $C_L=15pF$ , S2 Closed		25	50	ns
Receiver Disable Time from Low	$t_{RLZ}$	Figure 5 and 9, $C_L=15pF$ , S1 Closed		25	50	ns
Receiver Disable Time from High	$t_{RHZ}$	Figure 5 and 9, $C_L=15pF$ , S2 Closed		25	50	ns
Time to Shutdown	$t_{SHDN}$	(Note 4)			1000	ns
Driver Enable from Shutdown to Output High	$t_{DZH(SHDN)}$	Figure 4 and 7, $C_L=15pF$ , S2 Closed		3.0		$\mu s$
Driver Enable from Shutdown to Output Low	$t_{DZL(SHDN)}$	Figure 4 and 7, $C_L=15pF$ , S1 Closed		3.0		$\mu s$
Receiver Enable from Shutdown to Output High	$t_{RZH(SHDN)}$	Figure 5 and 9, $C_L=15pF$ , S2 Closed		3.0		$\mu s$
Receiver Enable from Shutdown to Output Low	$t_{RZL(SHDN)}$	Figure 5 and 9, $C_L=15pF$ , S1 Closed		3.0		$\mu s$

Note 4: The device is put into shutdown by bringing RE high and DE low.

Communication Function

Table1. Transmitting

Inputs			Outputs		Mode
RE	DE	DI	B	A	
X	1	1	0	1	Normal
X	1	0	1	0	Normal
0	0	X	High-Z	High-Z	Normal
1	0	X	High-Z	High-Z	Shutdown

Note: X=Don't care; High-Z=High Impedance

Table2. Receiving

Inputs			Outputs	Mode
RE	DE	A, B	RO	
0	X	$\geq -50\text{mV}$	1	Normal
0	X	$\leq -200\text{mV}$	0	Normal
0	X	Open/Shorted	1	Normal
1	0	X	High-Z	Shutdown

Note: X=Don't care; High-Z=High Impedance

Typical Operating Circuit

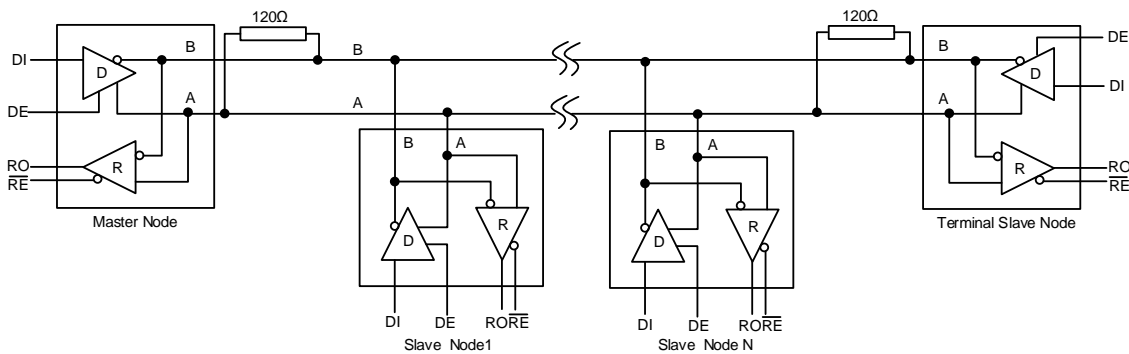
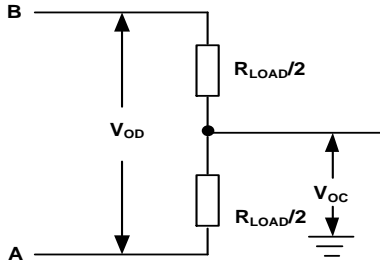
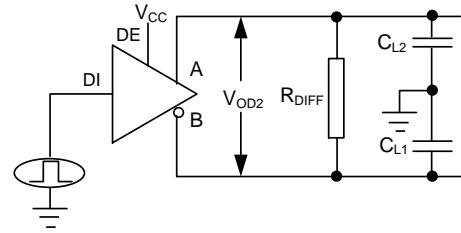

Figure 1. Typical Half-Duplex RS-485 Network

**Test Circuit**



**Figure 2. Driver DC Test Load**



**Figure 3. Driver Timing Test Circuit**

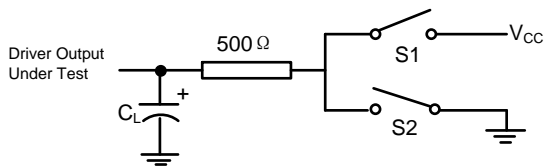

**Figure 4. Driver Enable/Disable Timing Test Load**

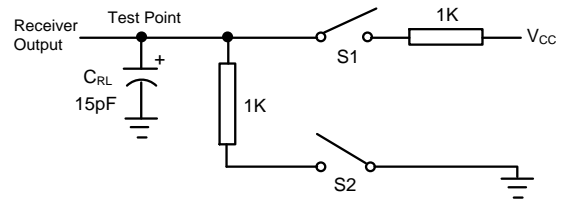

**Figure 5. Receiver Enable/Disable Timing Test Load**

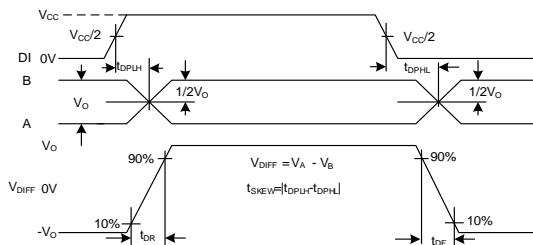

**Figure 6. Driver Propagation Delays**

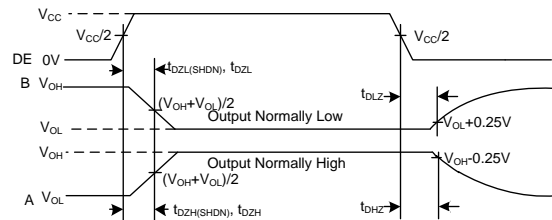

**Figure 7. Driver Enable and Disable Times**

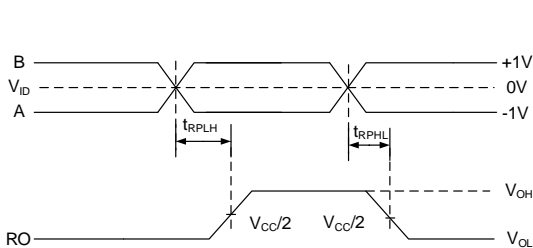

**Figure 8. Receiver Propagation Delays**

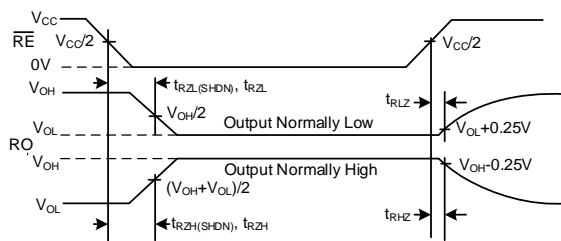

**Figure 9. Receiver Enable and Disable Times**



---

## **Detail Description**

The UM13088 high-speed transceivers for RS-485 communication contain one driver and one receiver. These devices feature fail-safe circuitry, which guarantees a logic-high receiver output when the receiver inputs are open or shorted, or when they are connected to a terminated transmission line with all drivers disabled. The UM13088 driver slew rates are not limited, making transmit speeds up to 10Mbps possible.

The UM13088 RS-485 transceivers operate with a  $V_{CC}$  voltage supply from 3V to 5.5V. Drivers are output short-circuit current limited. Thermal shutdown circuitry protects drivers against excessive power dissipation. When activated, the thermal shutdown circuitry places the driver outputs into a high impedance state.

### **Fail-Safe**

The UM13088 guarantees a logic-high receiver output when the receiver inputs are shorted or open, or when they are connected to a terminated transmission line with all drivers disabled. This is done by setting the receiver threshold between -50mV and -200mV. If the differential receiver input voltage (A-B) is greater than or equal to -50mV, RO is logic high. If A-B is less than or equal to -200mV, RO is logic low. In the case of a terminated bus with all transmitters disabled, the receiver's differential input voltage is pulled to 0V by the termination. With the receiver thresholds of the UM13088, this results in a logic high with a 50mV minimum noise margin. Unlike previous fail-safe devices, the -50mV to -200mV threshold complies with the  $\pm 200$ mV EIA/TIA-485 standard.

## **Applications Information**

### **256 Transceivers on the Bus**

The standard RS-485 receiver input impedance is 12k $\Omega$  (one unit load), and the standard driver can drive up to 32 unit loads. The Union family of transceivers have a 1/8 unit load receiver input impedance (96k $\Omega$ ), allowing up to 256 transceivers to be connected in parallel on one communication line. Any combination of these devices and/or other RS-485 transceivers with a total of 32 unit loads or less can be connected to the line.

### **Driver Output Protection**

Two mechanisms prevent excessive output current and power dissipation caused by faults or by bus contention. The first, a foldback current limit on the output stage, provides immediate protection against short circuits over the whole common-mode voltage range. The second, a thermal shutdown circuit, forces the driver outputs into a high-impedance state if the die temperature becomes excessive.

### **Typical Applications**

The UM13088 transceivers are designed for bidirectional data communications on multipoint bus transmission lines. To minimize reflections, the line should be terminated at both ends in its characteristic impedance, and stub lengths off the main line should be kept as short as possible.

Package Information

SOP8

Outline Drawing

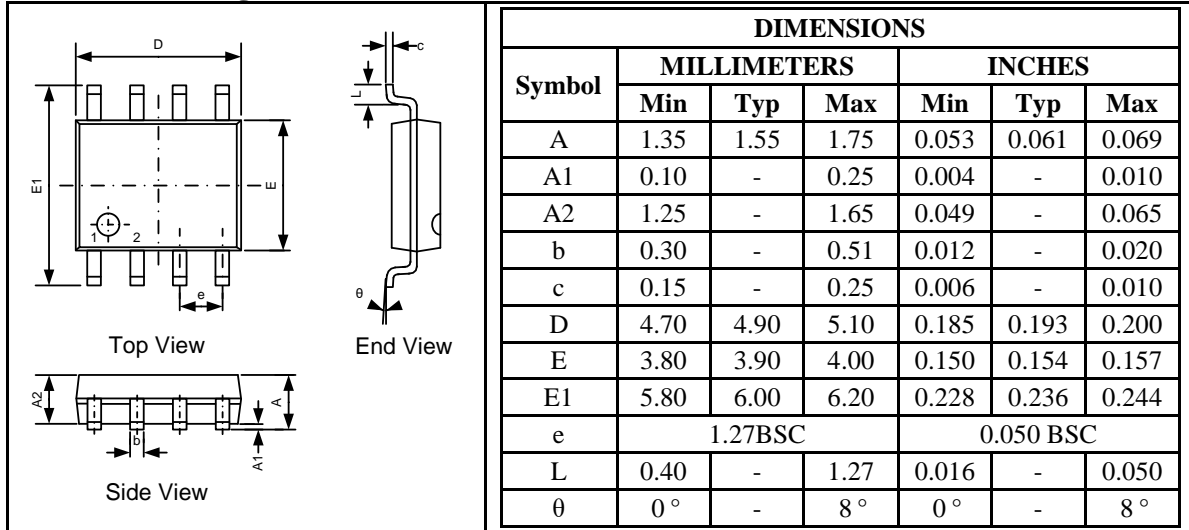

Land Pattern

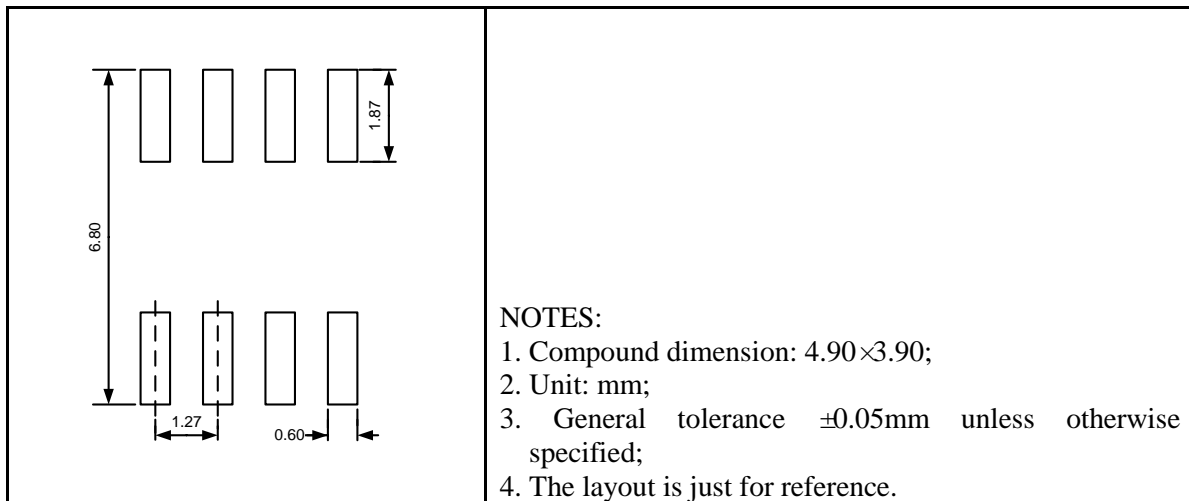

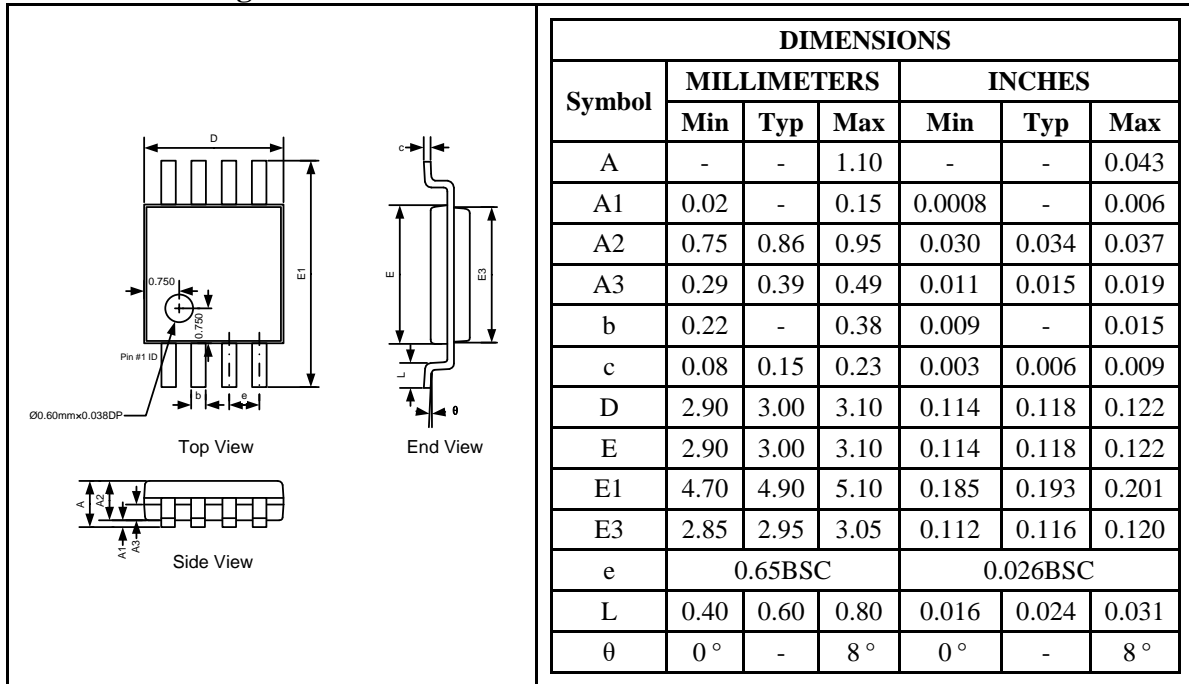
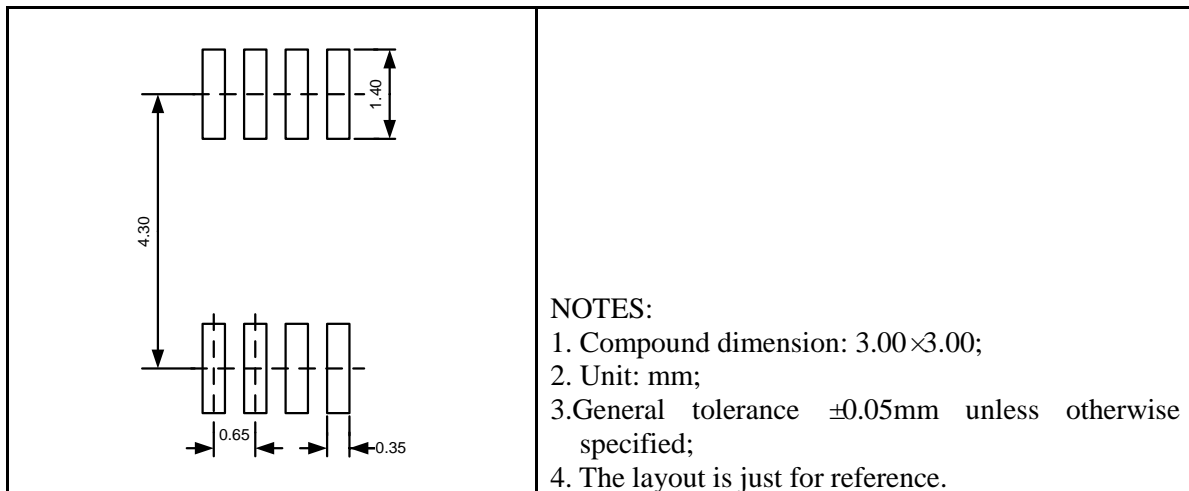
**MSOP8**
**Outline Drawing**

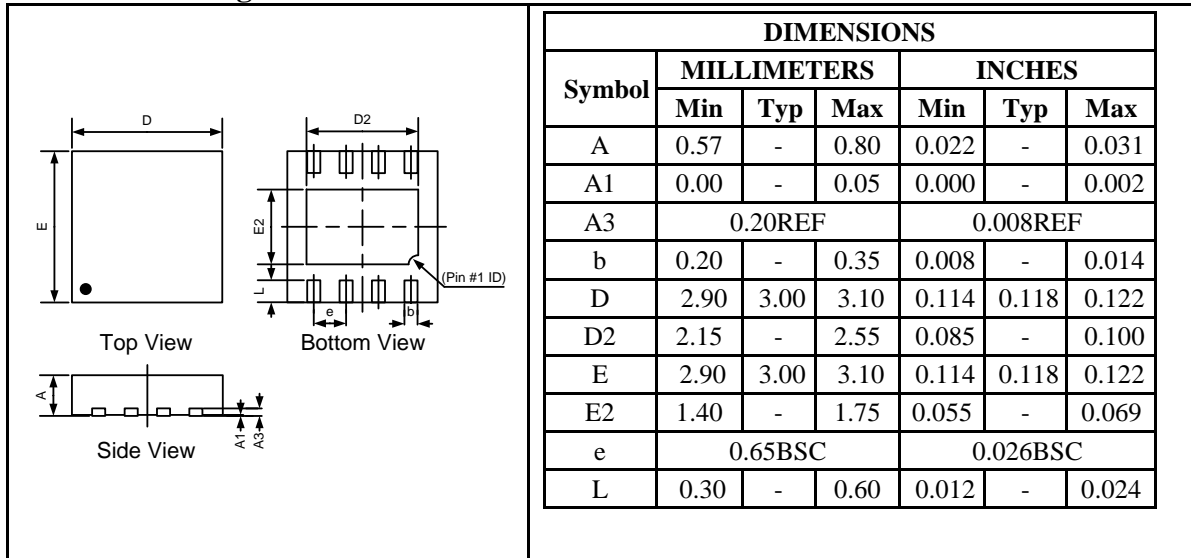
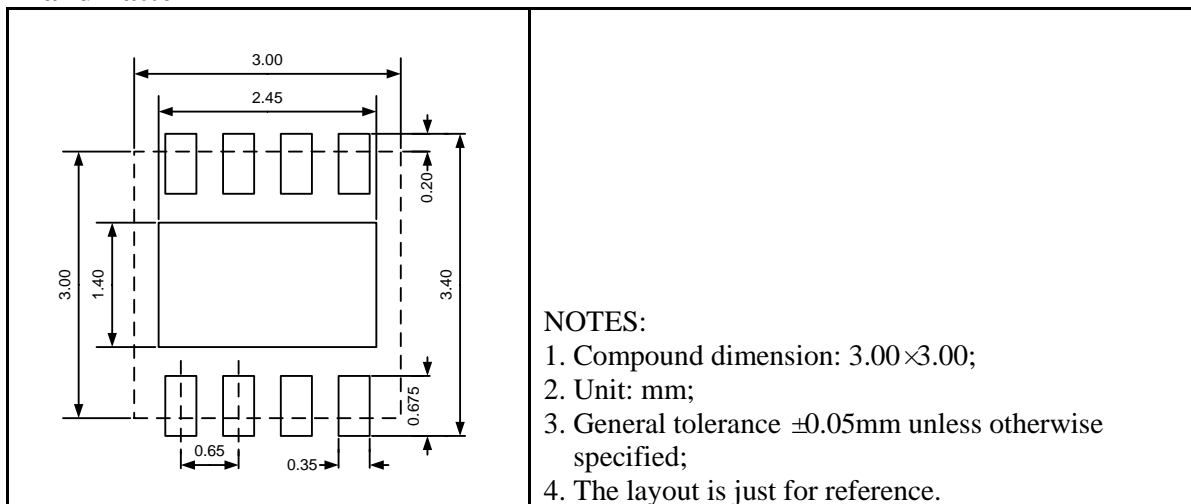
**Land Pattern**

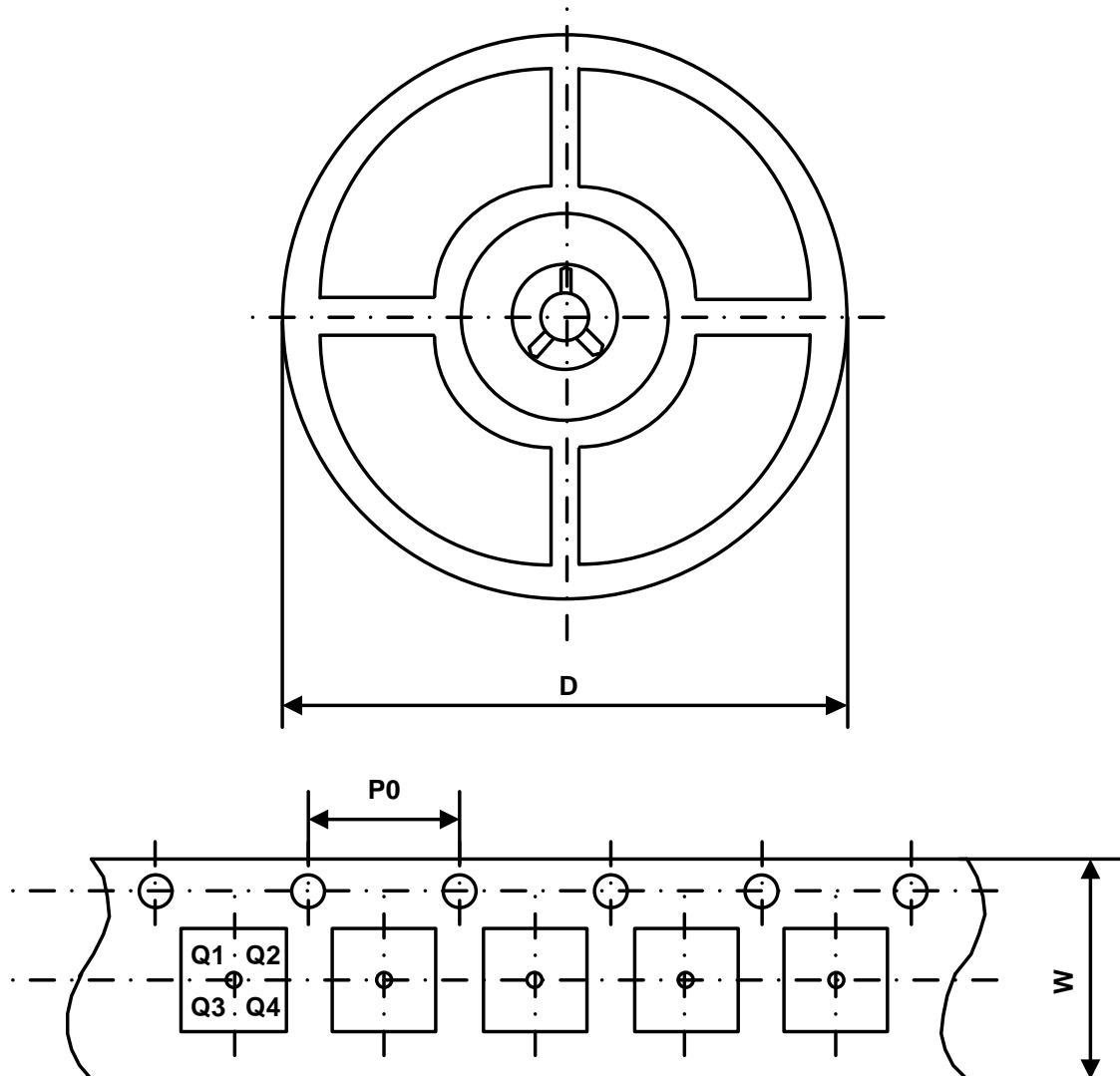
**DFN8 3.0×3.0**
**Outline Drawing**

**Land Pattern**

**Packing Information**

Part Number	Package Type	Carrier Width (W)	Pitch (P0)	Reel Size (D)	PIN 1 Quadrant
UM13088S8	SOP8	12 mm	4 mm	330 mm	Q1
UM13088M8	MSOP8	12 mm	4 mm	330 mm	Q1
UM13088DA	DFN8 3.0×3.0	12 mm	4 mm	330 mm	Q1

---

## GREEN COMPLIANCE

Union Semiconductor is committed to environmental excellence in all aspects of its operations including meeting or exceeding regulatory requirements with respect to the use of hazardous substances. Numerous successful programs have been implemented to reduce the use of hazardous substances and/or emissions.

All Union components are compliant with the RoHS directive, which helps to support customers in their compliance with environmental directives. For more green compliance information, please visit:

[http://www.union-ic.com/index.aspx?cat\\_code=RoHSDeclaration](http://www.union-ic.com/index.aspx?cat_code=RoHSDeclaration)

## IMPORTANT NOTICE

The information in this document has been carefully reviewed and is believed to be accurate. Nonetheless, this document is subject to change without notice. Union assumes no responsibility for any inaccuracies that may be contained in this document, and makes no commitment to update or to keep current the contained information, or to notify a person or organization of any update. Union reserves the right to make changes, at any time, in order to improve reliability, function or design and to attempt to supply the best product possible.



Union Semiconductor, Inc

Add: Unit 606, No.570 Shengxia Road, Shanghai 201210

Tel: 021-51093966

Fax: 021-51026018

Website: [www.union-ic.com](http://www.union-ic.com)